

Your Trustworthy Industrial IoT Partner



- Official Shop: <https://shop.usriot.com/>
- Inquiry Email: inquiry@usriot.com
- For Strategic Partnership: ceo@usr.cn
- Floor 12 and 13, CEIBS of Maolingshan, Lixia District, Jinan, Shandong, China
- Skype / WhatsApp : +86 13405313834



YouTube



Facebook



**Industrial IoT Gateways Ranked First in China by
Online Sales for Seven Consecutive Years***

*Data from China's Industrial IoT Gateways Market Research in 2023 by Frost & Sullivan

Industrial IoT Gateways Ranked First in China by Online Sales for Seven Consecutive Years*

*Data from China's Industrial IoT Gateways Market Research in 2023 by Frost & Sullivan



National "little giant" Firms National High-Tech Enterprise Shandong Gazelle Enterprise

<p>28M\$ Funding</p> <p>28 Million Dollars Series A B C Rounds Total</p>	<p>97⁺ Countries</p> <p>97+ Countries using our products</p>	<p>15 M⁺</p> <p>15 M+ Devices deployed worldwide</p>	<p>3 Business</p> <p>USR IOT networks, USR IIOT solutions, PUSR EMS</p>	<p>2 Factories</p> <p>Jinan/Suzhou</p>
---	--	--	--	---

Your Trustworthy Industrial IoT Partner

Leading industrial IoT software and hardware solutions provider
Shandong USR IOT Company Limited

COMPANY PROFILE

With more than 600 employees and nearly \$28 million in financing

Has own factory with full industry chain service capabilities from chips to cloud.

Provides customers with communication gateways, networking modules, cloud platforms and IoT solutions

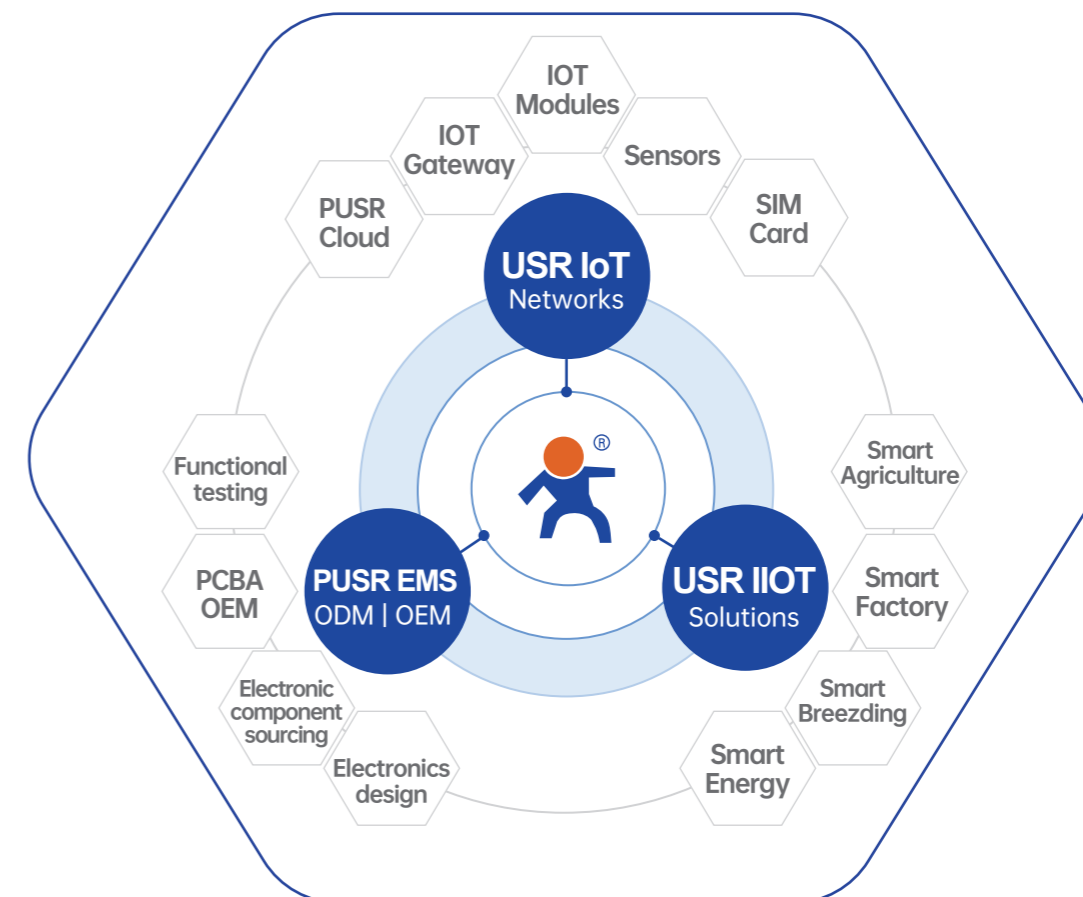

Corporate Video

FACTORY OVERVIEW

10000

Suzhou: 7755 Square Meters(m²)
Jinan: 3400 Square Meters(m²)

1000

Component placements per Day:
10 Million pcs
Capacity/Month:
More than hundreds of million

40%

R&D staff

11

SMT lines



Factory Video

Professional

Multi-layer PCB board design and various RF tuning capabilities

Quality

ISO9001:2015 certification
IATF16949:2016 certification

Delivery Time

Two factories, Professional supply chain management.

COMPANY HISTORY

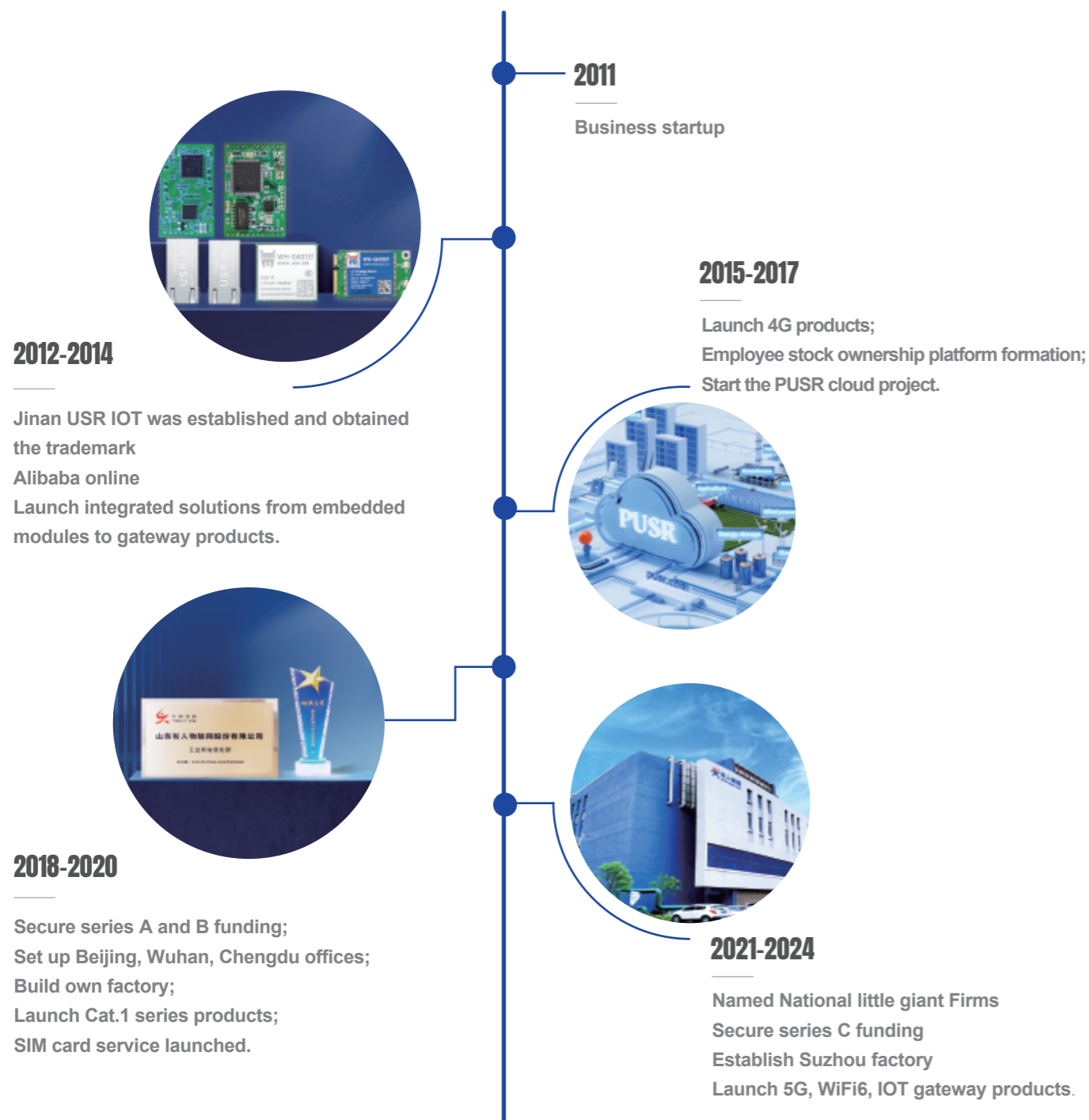

CONTENT

Company Introduction	01	Industrial Edge Control	
Factory Overview	03	Industrial IoT Gateway	23
Company History	05	M Series	
Business Layout	07	Open Source Gateway	
Industrial Network Infrastructure		Industrial Device Networking	
Industrial Router	09	Serial to ETH/WiFi/Cellular	29
5G Industrial Router		Industrial 4G Modems	
4G Industrial Router		Serial to Ethernet	
Ethernet Switch	15	Serial to WiFi	
Industrial Switch		LoRa/ Swarm Networking	39
Ethernet Switch		LoRaWAN/Swarm AD hoc network	
Wireless Network	19	Swarm Converter	
AP+AC Wireless Roaming		IoT Modules	43
Wireless Bridge		IoT Platform	
		Network Management	45
		SIM Card	
		ODM/EMS	
		Industry Product	47

YOUR TRUSTWORTHY INDUSTRIAL IOT PARTNER

Application

Cloud Platform









PUSR Cloud [®] mp.usriot.com

- Device And Cloud Integration
- Low Code Development















Zero Programming, Drag And Drop Widgets To Achieve Remote Monitoring

DEVICES CONNECTED **2 Million+**
PAID USERS **1000+**

Communications

Industrial Network Infrastructure				Industrial Edge Control		Industrial Device Networking						
Cellular Router  <p>5G Cellular Router 5GWIFI6/CPE/FWA 5G AP 4G Cellular Router</p>				Industrial Switch  <p>Managed/Unmanaged/PoE</p>		Industrial IoT Gateways  <p>Node-RED M Series SD Card Caching IPC Arduino IoT Gateway</p>				Data Collection Gateway  <p>Data Collection Gateway LoRaWAN Swarm AD Hoc Network</p>		LoRa/Swarm Device
Industrial wireless  <p>AC Controller/ Wireless AP Wireless Client Wireless Bridge</p>				Open Source Controller				Serial device Networking  <p>4G DTU Serial Server Device Wireless WiFi Client CAN Communication</p>				
Modules 												

Perception

 Ammeter	 Smoke Detector	 Central Air Conditioning Controller	 Camera	 Fire Hydrant	 Express Cabinet	 PLC	 Meter	 Alarm Apparatus	 Charging Pile	 BMS	 Solar Photovoltaic Power Supply System	 Valve	 Frequency Changer	 Flowmeter
Building Automation			Smart City			Waterworks Management			New Energy			Factory Data Acquisition		

Industrial Router

5G Industrial Router



Surveillance Monitoring Solution

The NR520i is IP67 waterproof, enabling the device to work in harsh environments. With wireless connectivity, one network can be leveraged to provide video surveillance, WiFi. With low-latency, wireless connectivity, you can quickly and efficiently create secure networks for remote video surveillance in parks, farms, and ranches.

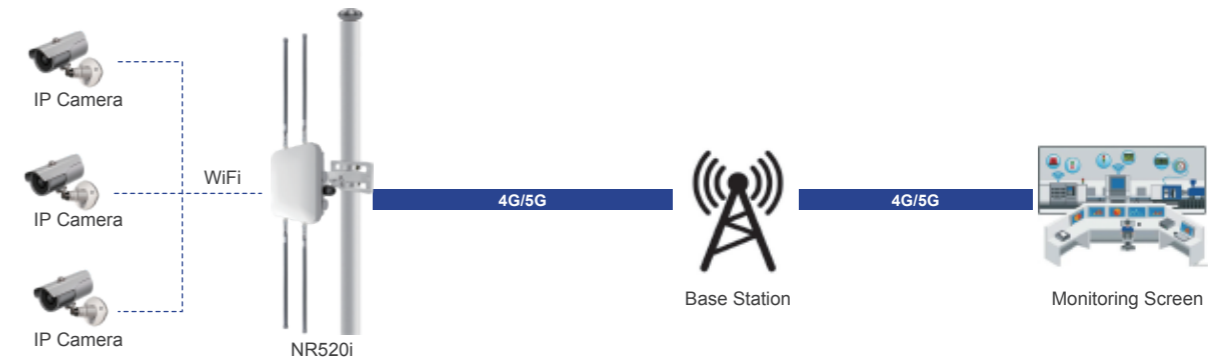

Smart Port Networking Project

PUSR 5G routers enable wireless remote access through the 5G base station. The oil temperature and pressure in the gearbox, along with the limit information of the mechanical transmission mechanism, as well as the deceleration and stop signals, are transmitted to the data center via the 5G router.



Case Video



Smart AGV Project

5G industrial routers provide wireless Internet access for AGV robots in motion. They offer high speed, large bandwidth, and low latency, enabling quick transmission of data, video, audio, and other information to the cloud platform for timely responses.

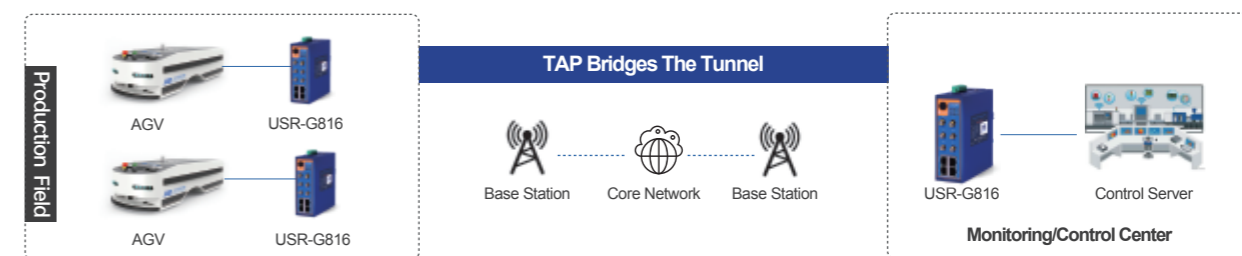

Product Video

Low Latency

Wide Bandwidth

Qualcomm Solution

Gigabit Port

Industrial Router

4G Industrial Router



Cleaning Robot Network

The robot's LiDAR and motherboard communicate in real time through USR-G806w networking and the control room's service platform. This allows remote control and monitoring of multiple cleaning robots on site. The 806w router also provides WiFi hotspots for on-site control and debugging by maintenance personnel.

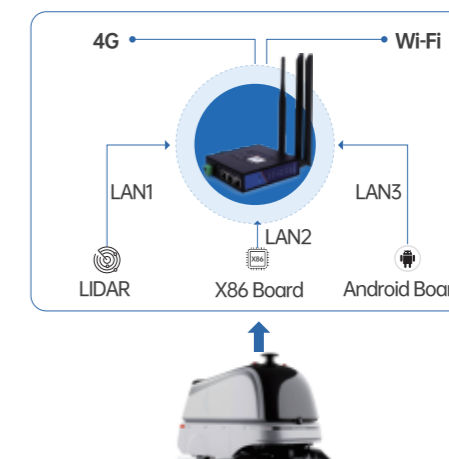

USR-G805s
Dual SIM Industrial 4G Router

USR-G781
RS232/485 4G Router

USR-G805
Single Ethernet Port Industrial 4G Router

USR-G809
I/O 4G Router Gateway

USR-G806s
Serial Port 4G Router with GNSS

USR-G806w
Qualcomm WiFi Industrial 4G Router



Smart Site

The USR-G806s features routing capabilities along with integrated serial port and GNSS. It can upload data from sensors that monitor temperature, humidity, and wind speed at industrial sites to the server via the 4G modem. This router provides real-time updates on the status of safety detection gates and explosion-proof cameras to the monitoring system through its routing function.

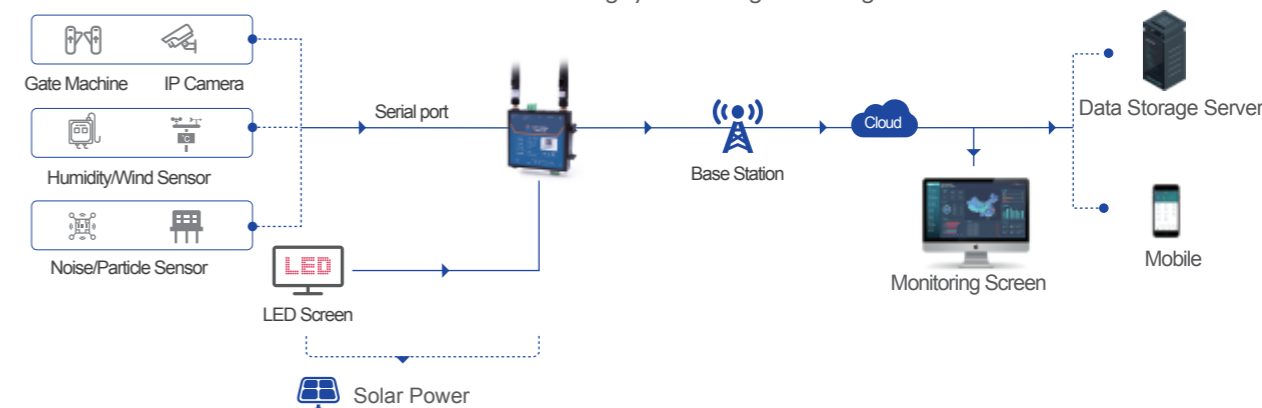

Remote Monitoring of ATM

Terminal ATM machines and IP cameras are connected to the router via Ethernet, access the Internet through 4G network, and establish VPN connections with the management center via the 4G router, forming a unified network with the central system. Terminal ATM machines and IP cameras can communicate directly with the central system's servers. The business data generated by the terminal ATM machines is directly transmitted to the central server's bank central system through the communication channel established by the router, ensuring the security of data communication.

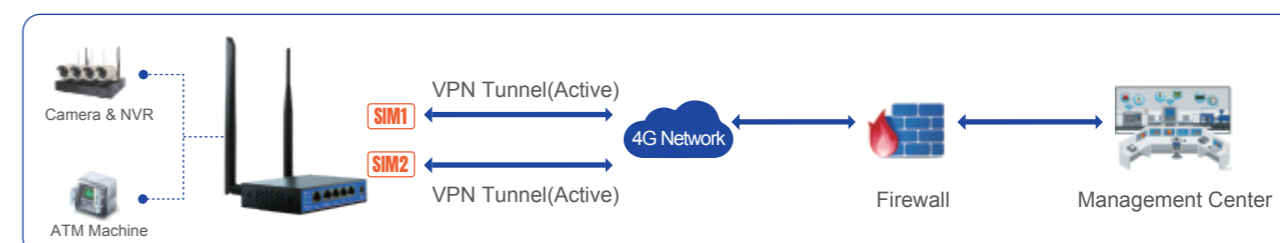

VPN



High Protection



Remote Management



Dual SIM

Key Parameters of 5G Routers

Model	USR-G816	U300	NR520X
Appearance			
Frequency Band	5G: n1/2/3/5/7/8/12/13/14/18/20/25/26/28/29/30/38/40/41/48/66/70/71/75/76/77/78/ 79 4G: B1/2/3/4/5/7/8/12/13/14/17/18/19/20/25/26/28/29/30/32/66/71/34/38/39/40/41/42/43/48 3G: B1/2/4/5/8/19		
SIM Slot	2*mini-SIM(2FF)	1*micro-SIM(3FF)	1*Mini-SIM(2FF)
eSIM	Customized	--	--
Region	Global		
Ethernet Port	4*10/100/1000 Mbps RJ45 port, 1WAN+3LAN	4*10/100/1000 Mbps RJ45 port, 1WAN/LAN+2LAN	1*10/100/1000 Mbps RJ45 port, WAN/LAN
WiFi Standard	Dual band WiFi 5, 802.11 a/b/g/n/ac	Dual band WiFi6, 802.11a/b/g/n/ac/ax	Dual band WiFi6, 802.11a/b/g/n/ac/ax
WiFi Mode	AP/STA/AP+STA	AP/STA/AP+STA	AP/STA/AP+STA
Serial Port	1*RS485/232	--	--
GNSS	Customized	--	--
VPN	PPTP, L2TP	IPSec, L2TP, PPTP	IPSec, L2TP, PPTP
Power Supply	DC 9-36V	DC 12V	48V PoE(802.3at)
EMC Protection	IEC61000 level 3	IEC61000 level 2	IEC61000 level 3
Operating temperature	-35°C ~ +75°C	-10°C~+45°C	-40°C~+70°C
Housing	Metal housing, IP30 protection	Metal housing, IP30 protection	Plastic housing, IP67 protection
Installation	Desktop, wall mounting and DIN-rail mounting	Desktop, wall mounting	Pole mounting
Dimensions(mm)	125.0*103.0*45.0mm (L*W*H, antenna pedestal, terminal block and DIN Rail are not included)	170.8*86*31.2mm (L*W*H, antenna pedestal is not included)	263.6*198.46*82mm

Key Parameters of 4G Routers

Model	USR-G805s	USR-G806w	USR-G806s	USR-G809	USR-G781	USR-G805
Appearance						
Frequency Band	LTE Cat 4: B1/2/3/4/5/7/8/12/13/18/19/20/25/26/28/66/ 34/38/39/40/41 3G: B1/2/4/5/6/8/19 2G: B2/3/5/8			-EAU version LTE Cat 4: B1/3/5/ 7/8/20/28/38/40/41 3G: B1/5/8 2G: B3/5/8	-E version LTE CAT4: B1/3/ 5/7/8/20/38/40/41 3G: B1/5/8 2G: B3/B8	ECAUX version LTE Cat4: B1/2/3/4/ 5/7/8/28/40 3G: B1/2/4/5/8 2G: B2/3/5/8
SIM Slot	2*nano-SIM(4FF)	1*nano-SIM(4FF)	1*mini-SIM(2FF)	1*mini-SIM(2FF)	1*mini-SIM(2FF)	1*mini-SIM(2FF)
eSIM	Customized	--	--	--	--	--
Region	Global			Europe	-E: EMEA & APAC, -AU: Australia & Latin America	-ECAUX: Australia & Latin America & New Zealand & Taiwan -ECEUX: EMEA & Thailand & India
Ethernet Port	5*10/100 Mbps RJ45 port, 1WAN+1WAN/ LAN+3LAN	3*10/100 Mbps RJ45 port, 1WAN/LAN+2LAN	2*10/100 Mbps RJ45 port, 1WAN/LAN+1LAN	4*10/100 Mbps RJ45 port, 1WAN/LAN+3LAN	2*10/100 Mbps RJ45 port, 1WAN/LAN+1LAN	1*10/100 Mbps RJ45 port, 1LAN
WiFi Standard	2.4G, 802.11b/g/n					
WiFi Mode	AP/STA/AP +STA	AP/STA/AP +STA	AP	AP	--	--
Serial Port	--	--	1*RS485	1*RS232/485	1*RS232/485	--
IO	--	--	--	2*Digital input 2*Digital output	--	--
GNSS	--	--	✓	Customized	Customized	--
SMS	✓	--	✓	✓	✓	--
Power Supply	DC 9-36V	DC 9-36V	DC 9-36V	DC 9-36V	DC 9-36V	DC 9-36V
EMC Protection	IEC61000 level 2	IEC61000 level 3	IEC61000 level 2	IEC61000 level 3	IEC61000 level 3	IEC61000 level 2
Operating temperature	-20°C ~ +70°C	-20°C~+70°C	-20°C ~ +70°C	-20°C ~ +70°C	-35°C~+75°C	-20°C~70°C
Housing	Metal housing, IP30 protection					
Installation	Desktop, wall mounting	Desktop, wall mounting and DIN-rail mounting	Desktop, wall mounting and DIN-rail mounting	Wall mounting and DIN-rail mounting	Desktop, wall mounting	Desktop, wall mounting, DIN-rail mounting
Dimensions (mm)	127*84*27 (L*W*H)	104*102*28 (L*W*H)	112*84*25 (L*W*H)	125*103*45 (L*W*H)	123*112*28 (L*W*H)	86*70*25 (L*W*H)

Ethernet Switch

USR-ISG Series
Industrial Switch

USR-SG Series
Ethernet Switch

USR-SDR050-L
Unmanaged Industrial Switch

USR-ISG Series
Layer 3 Managed Switch

USR-S1210P
Gigabit PoE Ethernet Switch



Product Video

 Self-healing
Ring Network

 High
Speed

 Fiber and
Copper Ports

 High Protection
Capability

Industrial Automation

The smart factory focuses on uploading data from sensors, PLCs, collection and detection equipment through a collection gateway. It uses MES and other server-side systems for data analysis and business processing. Gigabit industrial ring network switches provide networking and service access, while the carrier-grade Self-Healing ring network, based on ERPS, ensures service redundancy protection with a 50ms recovery time.

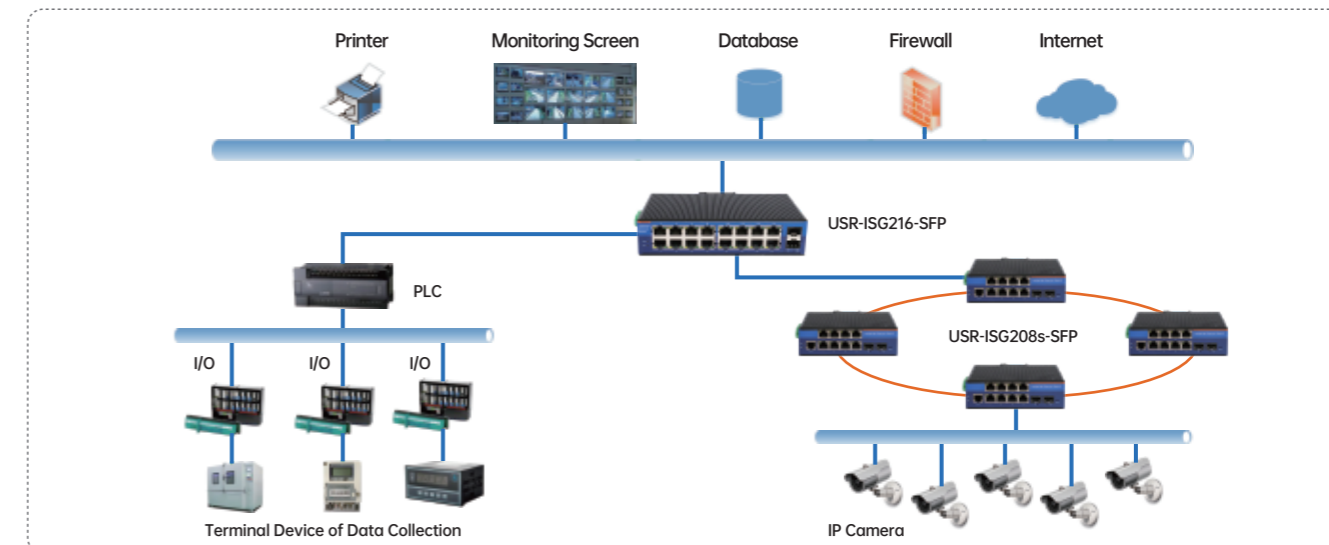

Smart Transportation

Highway road monitoring system is mainly composed of traffic police monitoring, signal control, vehicle speed measurement, weather detection, variable speed limit board and so on. 10 Gigabit + Gigabit industrial ring network switches are used for networking and service access. The 50ms ring network self-healing ensures that all services have several redundant links. If a single point or segment fails, the system still runs normally.

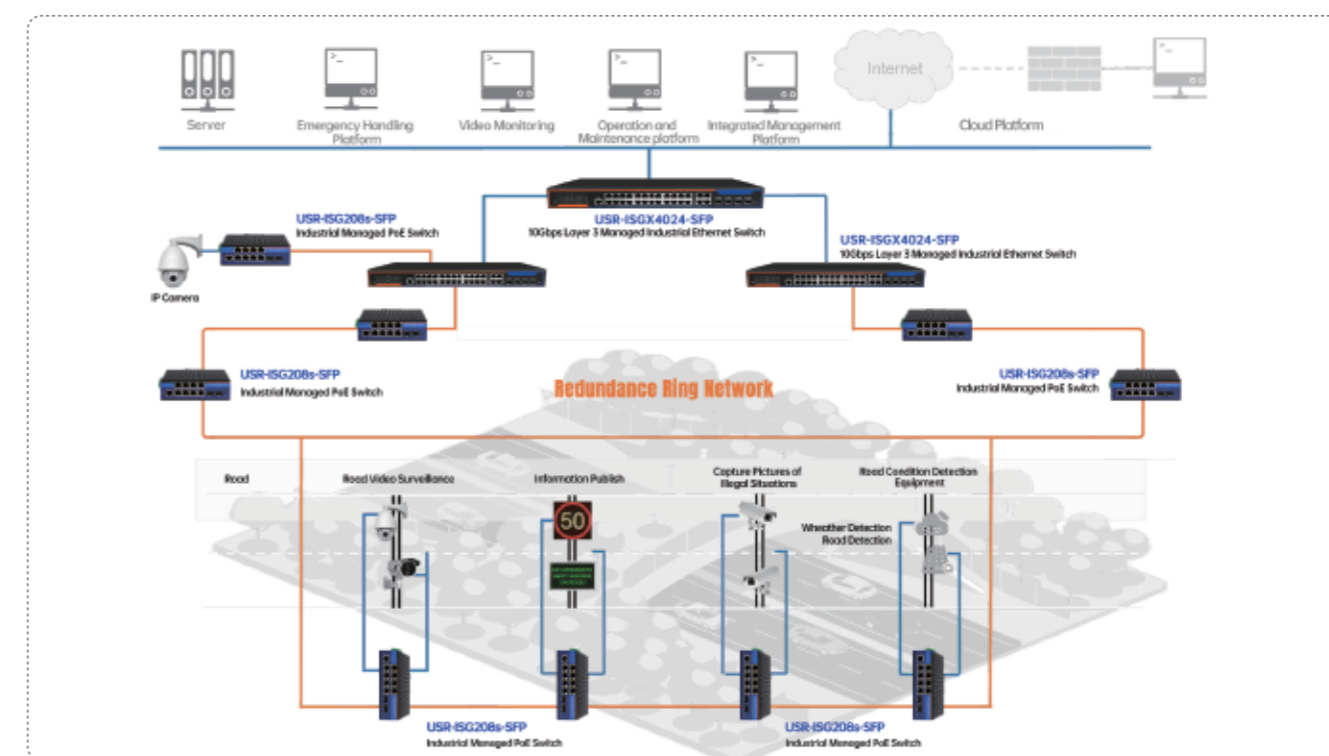



Industrial Switch

Model	USR-ISF005	USR-ISG005	USR-ISF008	USR-ISG008	USR-ISG008P	USR-ISG016
Appearance						
Feature	5 RJ45 Ports, 100M	5 Gigabit RJ45 Ports	8 RJ45 Ports, 100M	8 Gigabit RJ45 Ports	8 Gigabit RJ45 Ports with PoE	16 Gigabit RJ45 Ports
Power Supply	DC9.6-60V, Redundant Power Supply				DC48-57V passive PoE, Redundant Power Supply	DC12~52V, Dundant Power Supply
EMC Protection	IEC6000 Level 3				IEC6000 Level 4	
Operating Temperature	-40~75°C				-40 ~ 85°C	
Housing	Aluminum Housing					
Installation	Desktop/DIN Rail Mounting					
Dimensions (mm)	118*96*47.5				156*113*48	191*144*46
Web Configuration	Not Supported					

Model	ISG108P-SFP	ISG204-SFP	ISG208s-SFP	ISG216-SFP	ISG2024P-SFP	ISGX4024-SFP
Appearance						
Feature	Gigabit PoE Ports, 1 SPF+8 RJ45 Unmanaged	Gigabit Ports, 2 SPF+4 RJ45, Layer 2 Managed	Gigabit Ports, 2 SPF+8 RJ45, Advanced Layer 2 Managed	Gigabit Ports, 2 SPF+16 RJ45, Unmanaged	Gigabit PoE Ports, 2 SPF+24 RJ45, Layer 2 Managed	10 Gigabit Ports, 4 SPF+24 RJ45, Layer 3 Managed
Power Supply	DC48-57V Passive PoE, Redundant Power Supply	DC12~52V, Dundant Power Supply			AC100 ~ 240V	DC36 ~ 72V AC/DC110 ~ 240V
EMC Protection	IEC61000 Level 4					
Operating Temperature	-40~85°C				-40 ~ 80°C	
Housing	Aluminum Housing					
Installation	Desktop/DIN Rail Mounting				1U Rack Mounting	
Dimensions (mm)	143*101*44	144*104*48	144*104*48	176*136*47	442*325*44	442*194*44
Web Configuration	--	✓		--	✓	
Layer 2 Managed	--	VLAN, ERPS Ring Protocols Supported			--	VLAN, ERPS Ring Protocols Supported
Routing Protocols	--				Static and Dynamic Routing Protocols	

Business Switch

Model	USR-SF1005	USR-SG1005	USR-SF1008	USR-SG1008	USR-S1210P
Appearance					
Feature	5 RJ45 Ports, 100M	5 Gigabit RJ45 Ports	8 RJ45 Ports, 100M	8 Gigabit RJ45 Ports	8 Gigabit RJ45 Ports with PoE, 1 Gigabit uplink RJ45 & 1 uplink SPF
Power Supply	12V1A, terminal block connector				DC54V/1.2A(DC54V/2.4A optional) POE 48V 802.3af/at<30W
EMC Protection	Low protection level				
Operating temperature	-5~45°C				
Housing	Mental Housing				
Installation	Desktop/DIN Rail Mounting				Desktop
Dimensions(mm)	100*77*26		140*90*26		200*100*26
Web Configuration	--				

Application of Smart City

Smart cities should meet the needs of image monitoring for public security management, urban management, disaster accident warning, traffic, security, etc., and use the "digital, networked, integrated, and intelligent" safe city monitoring to maintain a good social security environment. The use of ten gigabit + Gigabit industrial ring network switch for networking and service access, carrier-grade 50ms self-healing ring network based on ERPS, security cameras and other terminal equipment for service access and protection.

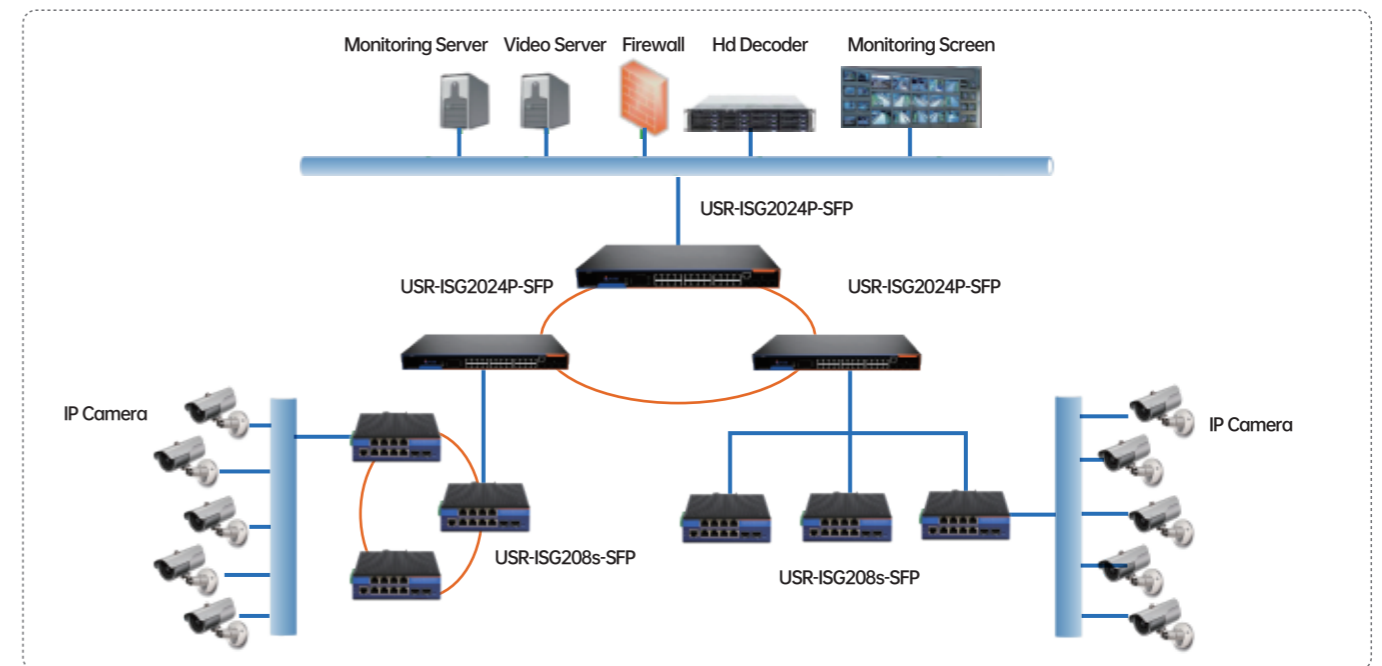



Factory Network Application

With the AP, AC and PoE switch provided by PUSR, the wireless dual-band anti-interference WiFi 6 network is constructed. The AGV robot car is loaded with WiFi client USR-W660, based on 802.11kv protocol, to realize seamless roaming between multiple aps and always working in the same LAN. With linkage wireless network IO controller to achieve elevator/gate management.

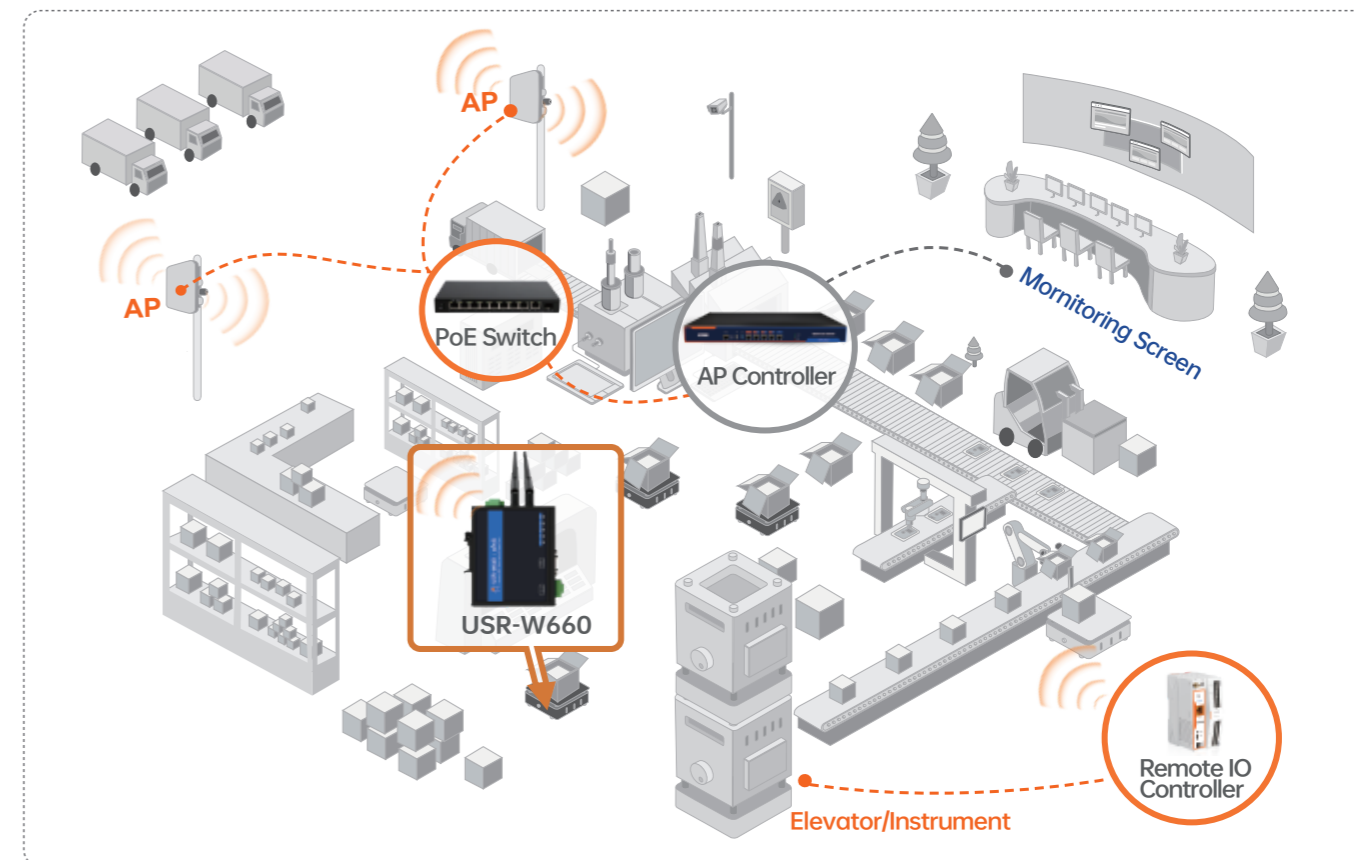

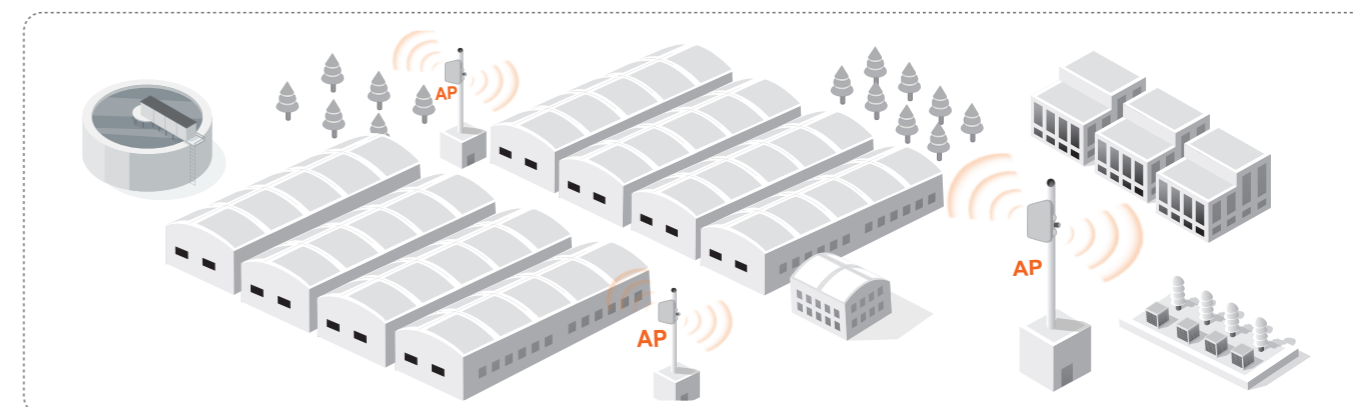

Breeding Park Hotspot Coverage

For the hot spot coverage in the breeding park, there are stringent requirements for waterproof and dustproof capabilities of the products. The NR520X model, equipped with an IP67 protection rating, supports the insertion of a SIM card to eliminate the need for network cables. It provides the park with high-speed, low-latency internet access, allowing handheld terminals and mobile phones to connect to the park's hot spots for online interaction. This solution offers an efficient and stable network for the digital management of the park.



- 
Qualcomm
Solution
- 
Gigabit
Port
- 
Dual Band
WiFi 6
- 
IP67
Waterproof
- 
Encryption
Protection

Key Parameters of AP

Model	AP310i	AP(NR)520X	AP (NR) 530X
Appearance			
WiFi 6	AX3000 (2.4G+5G)	AX3000 (2.4G+5G)	AX7800 (2.4G+5G ¹ +5G ²)
5G NR	--	✓	✓
Ethernet Ports	1*2.5GWAN+1*1GLAN	1*1GWAN/LAN	1*2.5GWAN/LAN
PoE	✓ (WAN)	✓	✓
Dimension (mm)	190*190*40	263.6*198.46*82	263.6*198.46*82
EMC	IEC61000 Class B Level 3		
Operating temperature	0°C~+40°C	-40°C~+70°C	-40°C~+70°C
Installation	Ceiling/Wall Mounting	Pole Mounting	Pole Mounting
IP Rating	IP30	IP67	

Key Parameters of AC

Model	AC200	AC1000
Appearance		
Ethernet Ports	1*1G WAN+4*1G LAN	1*1G WAN+4*1G LAN
PoE	✓ (PoE out)	--
Power Supply	DC53.5V/1.22A	AC100~240V 50/60Hz
EMC	IEC61000 Class Level 2	
Operating temperature	0°C ~+45°C	0°C ~+45°C
Installation	Desktop/Wall/DIN Rail Mounting	Desktop/1U Rack Mounting
Dimension (mm)	110*95*25	440*220*44.5



Wireless Bridge Wireless network

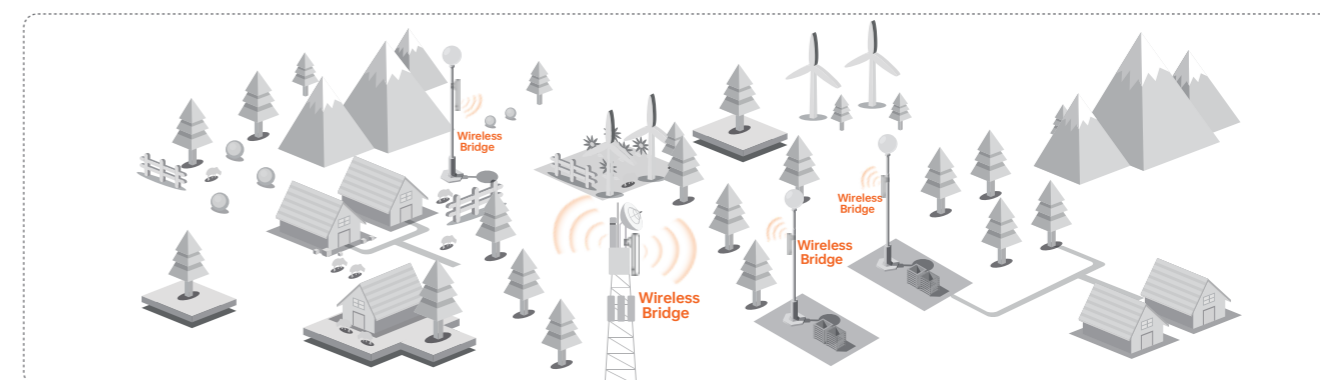

Video Surveillance Solution

In scenarios such as construction sites, park, oil fields, and forests where it is difficult to deploy network cables, wireless bridge technology can be used to transmit video data in place of network cables, offering less interference and longer transmission distances.



Model	ST508E	ST515N
Appearance		
Max Coverage(P2P)	Recommended: 1KM Max: 2KM	Recommended: 3KM Max: 5KM
Max coverage(P2MP)	Recommended: 0.5KM Max: 1KM	Recommended: 1KM Max: 3KM
Antenna	8dBi	15dBi
Dimension(mm)	141*77.5*53	158*97*38
Installation	Wall/Pole mounting	Pole Mounting
Operating temperature	-40°C ~ +70°C	
EMC	IEC61000 Class B Level 3	
Power Supply	12 ~24V DC Passive POE	
Power Adapter	100~ 240 VAC	
Max Consumption	4.5W	
Ethernet port	1*WAN	
Protocols	Static IP, DHCP, PPPoE	
PoE	PoE in	
IP Rating	IP64	IP66
Max Points	64	
Wireless protocol	IEEE802.11n/a, iPoll(Based on TDMA)	
Wireless frequency	4.9Ghz~6Ghz	

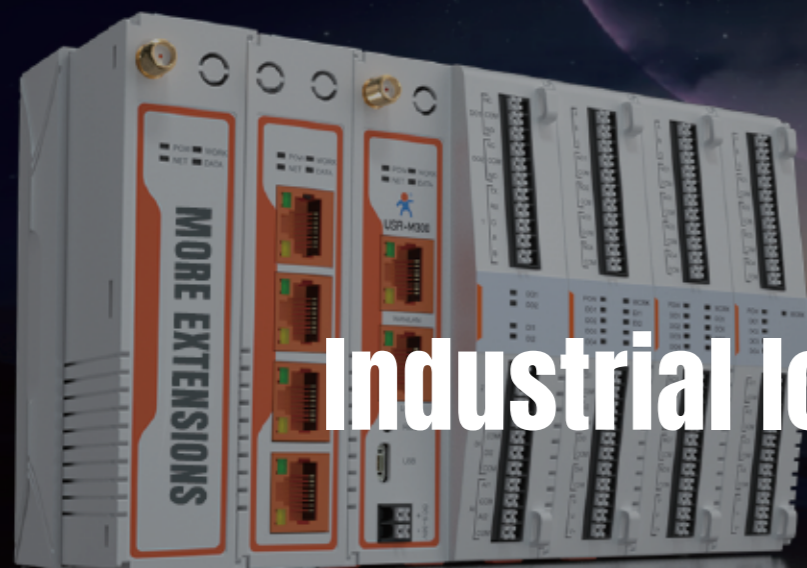

Industrial IoT Gateway

M Series

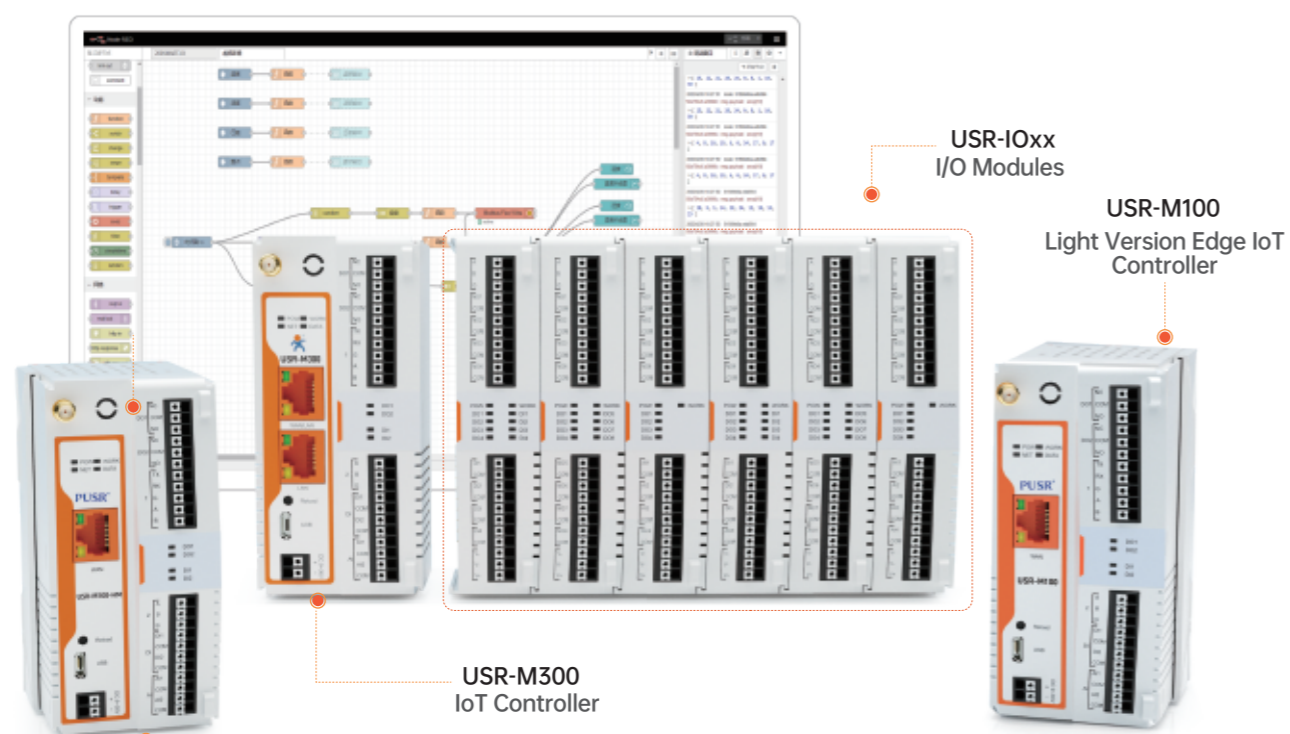

Product Video



Rich Protocols



Node-RED



IO Extendable



Data Security

The Unattended Pumping Station

USR-M300 supports graphical programming and can create a variety of control logic similar to a PLC. It can be connected to a touchscreen, camera, various sensors, instruments, frequency converters, electronic valves, and other equipment, as well as to the Pusr cloud for monitoring

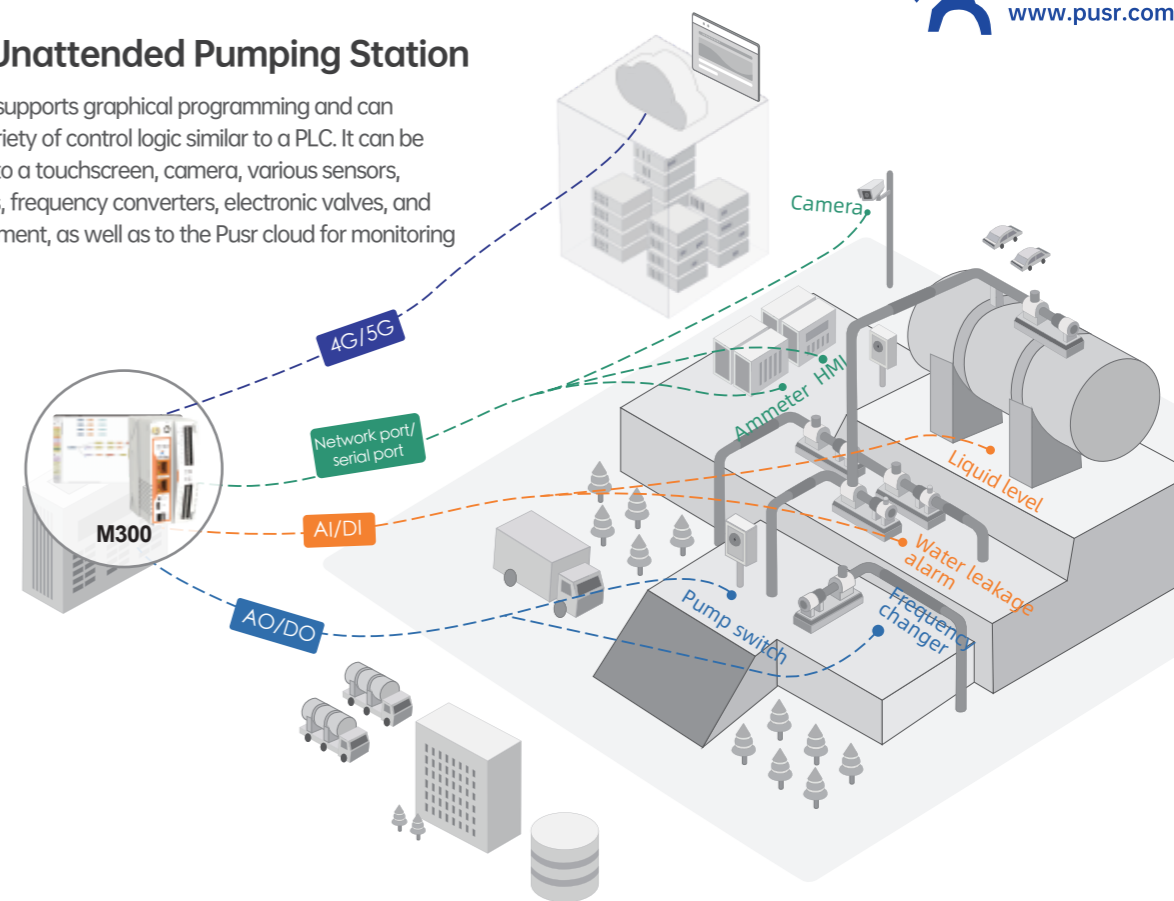

Intelligent Building Monitoring

USR-M100 can control solenoid valves, lighting, and access control systems. It supports the edge collections of the environmental and energy data, and connects to the server via MQTT.

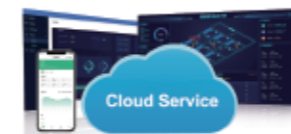

Remote monitoring/control on computer and mobile phone

4G/Ethernet

Data Cloud

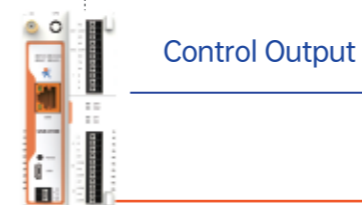

Barrier Gate

illumination



Air Conditioner

Entrance Guard



- Air Conditioner Status
- Access Control
- Lighting Status
- Ambient Temperature
- Water Valve
- Garage Door
- Smoke Detector

Gateway Key Parameter



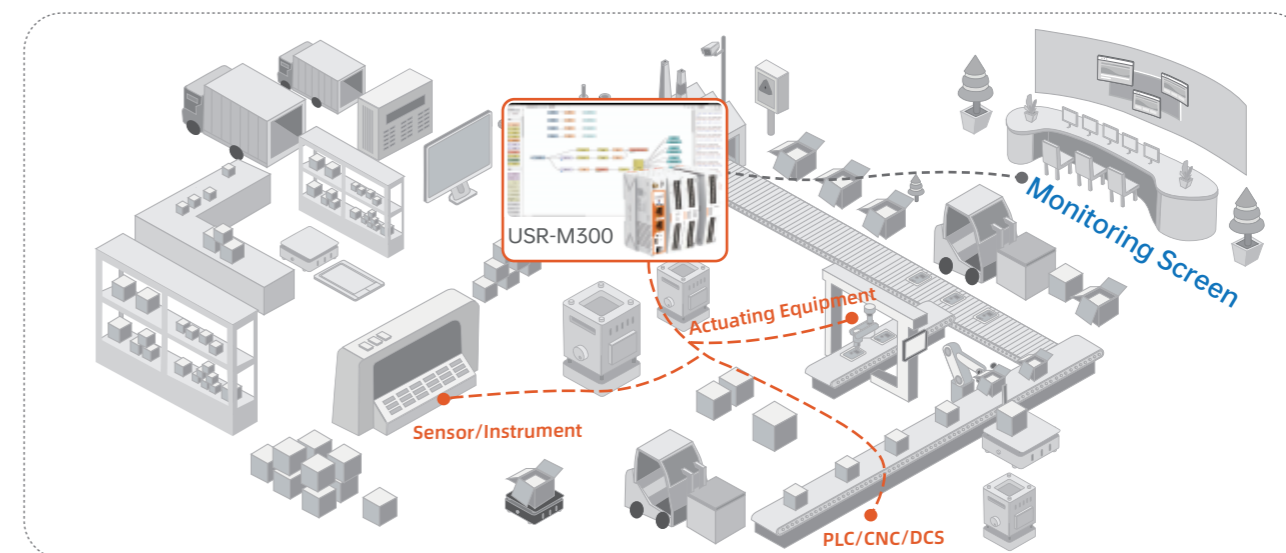

Model	USR-M300	USR-M100	USR-M100-HM
Appearance			
OS	Linux, MIPS architecture	RT-Thread	Open Harmony
Frequency Band (4G version)	4G: B1/2/3/4/5/7/8/12/13/18/19/20/25/26/28/66/34/38/39/40/41 3G: B1/2/4/5/6/8/19 2G: B2/3/5/8	4G: B1/3/5/7/8/20/28/38/40/41 3G: B1/5/8 2G: 850/900/1800	4G: B1/2/3/4/5/7/8/12/13/18/19/20/25/26/28/66/34/38/39/40/41 3G: B1/2/4/5/6/8/19 2G: B2/3/5/8
SIM Slot	1*micro-SIM		
Region	Global	Europe, Asia, Africa, Oceania, Brazil	Global
Ethernet Port	2*10/100 Mbps RJ45 port, 1WAN/LAN+1LAN	1*10/100 Mbps RJ45 port	1*10/100 Mbps RJ45 port
Serial Port	1*RS232/485 + 1*RS485	1*RS232/485 + 1*RS485	1*RS232/485, 1*RS485
IO	2*DO+2*DI+2*AI+ extendable module	2*DO+2*DI+2*AI+ extendable module	2*DO+2*DI+2*AI+ extendable module
GNSS	✓	Customized	✓
VPN	OpenVPN/PPTP/L2TP	--	--
Edge Computing Point	2000	300	1000
Communication Protocol	MQTT/TCP/HTTP	MQTT/TCP/HTTP/UDP	MQTT/TCP/HTTP
Active Reporting	Multiple Groups, JSON(8K)	1 Group, JSON(2K)	Multiple Groups, JSON(8K)
Downlink Protocol	Modbus TCP/RTU, DLT645/07, rich PLC protocol	Modbus TCP/RTU, DLT645/07	Modbus TCP/RTU, DLT645/07
Uplink Protocol	Modbus TCP/RTU, BACnet, OPC UA, Json	Modbus TCP/RTU, Json	Modbus TCP/RTU, Json
Node-RED	✓	--	--
Data Storage	2G	4K	SD card
Linkage Control Event	Up to 50	Up to 10	Up to 30
Power Supply	DC 9~36V		
EMC Protection	IEC61000 level 3		
Operating temperature	-20°C ~ +70°C	-25°C ~ +75°C	-20°C ~ +70°C
Housing	ABS housing, IP 30 protection		
Installation	Din rail mounting, wall mounting		
Host Dimensions (mm)	79.6*58*110		

Node-RED: Control the Entire Factory Process

The USR-M300 features an embedded Node-RED framework, allowing for graphical programming through drag-and-drop functionality. This enables quick creation of data collection, calculations, linkages, periodic execution, and other logic, ensuring complete control over the entire business process.



Key Parameters of the Extended

Model	USR-IO4040	USR-IO4440	USR-IO0080	USR-IO8000	USR-IO0404
Appearance					
Power Input Range	DC12-24V	DC12-24V	DC12-24V	DC12-24V	DC12-24V
No. of DI	4	0	0	8	0
No. of AI	0	4	0	0	4
No. of DO	4	4	8	0	0
No. of AO	0	0	0	0	4
Type of AI	--	Current	--	--	Current
Signal range of AI	--	4~20mA	--	--	4~20mA
Voltage range of DI	9~36V	--	--	9~36V	--
Type of DO	Relay	Relay	Relay	--	--
Capability of DO	3A	3A	3A	--	--
Type of AO	--	--	--	--	Current / Voltage
Signal range of AO	--	--	--	--	4-20mA0-10V
Communication port	RS485	RS485	RS485	RS485	RS485
Support extendable	✓	✓	✓	✓	✓
Dimensions(mm)	79.6*28*110	79.6*28*110	79.6*28*110	79.6*28*110	79.6*28*110

Industrial IoT Gateway

Open Source Gateway

Application of Industrial Computer in Storage Tank Monitoring

The industrial computer EG828 can serve as the core controller for the storage tank, collecting a wide range of parameters at the edge, such as BMS, PCS, access control, and fire temperature. It establishes a connection to the EMS system via MQTT.

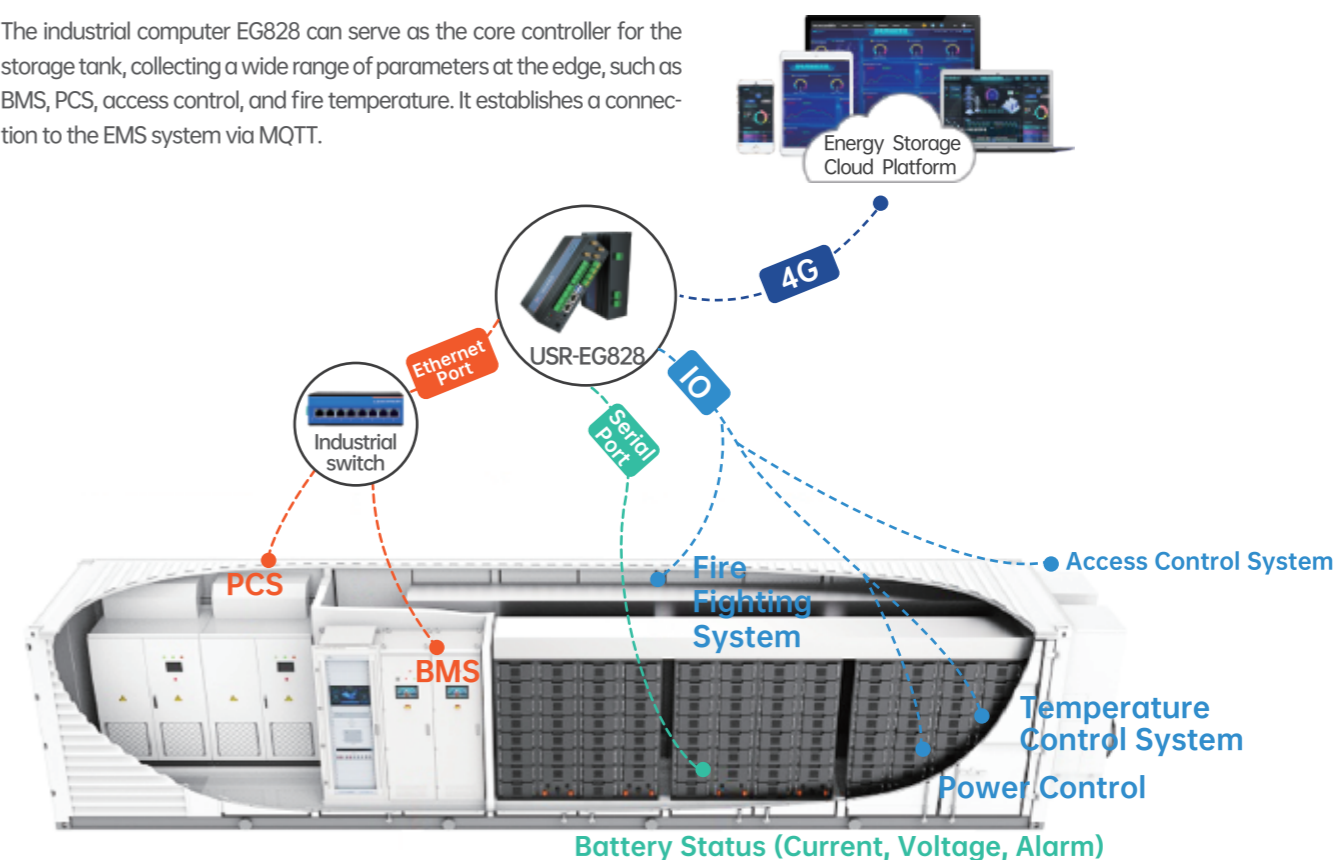

Key Parameters of the Open Source Controller

Model	USR-EG828	USR-EG118
Appearance		
Processor	Quad-Core ARM Architecture	ESP32
GPU	ARM G52 2EE GPU	--
OS	Linux	RTOS
4G	Global 4G Module	--
Ethernet Port	2*10/100 Mbps RJ45 port, 1*WAN/LAN+1*LAN	1*10/100 Mbps RJ45 port
WiFi	2.4G, 802.11b/g/n	2.4G, 802.11b/g/n
Serial Port	2*RS232, 2*RS485	1*RS232/485
I/O	4*AI, 4*DI, 2*DO	2*DO, 1*AI, 1*DI
USB	1*USB2.0, 1*USB3.0	--
CAN	1*CAN	--



- 
Qual-core ARM
- 
Open Source
- 
Linux OS
- 
Arduino
- 
Rich Interface

Serial to ETH/WiFi/Cellular

Industrial 4G Modems



Global Version



MQTT+SSL



DIN Rail/ Wall Mounting



Modbus Gateway



New Energy Vehicle Charging Pile System

Serial 4G modems are ideal for data transmission in the charging pile system. Operational data from charging piles can be quickly uploaded to the cloud using the 4G modem, enabling centralized management and the development of an intelligent charging service platform, which enhances user experience and operational efficiency.

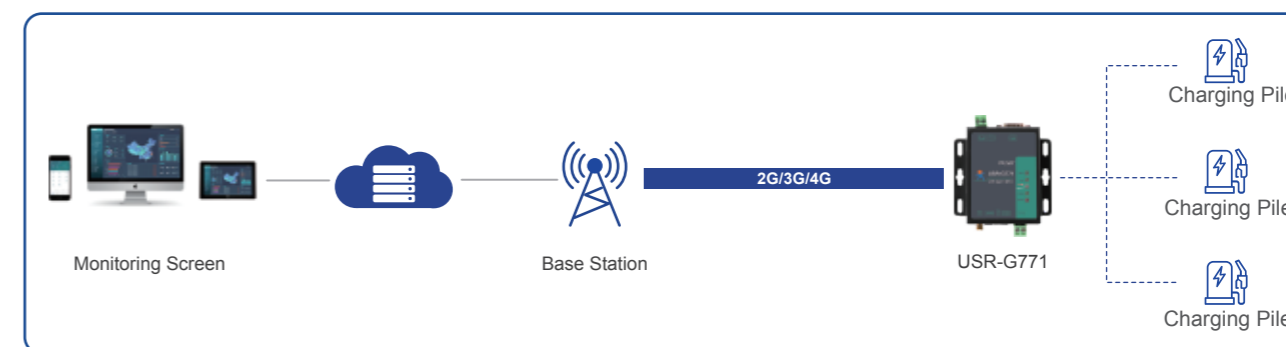

Distribution Box Data Acquisition Network Transmission

The compact size of the USR-DR154 makes it easy to use in tight spaces. It can quickly transmit electricity consumption data to the control room in real time via Modbus or to the cloud using MQTT, effectively reducing costs.

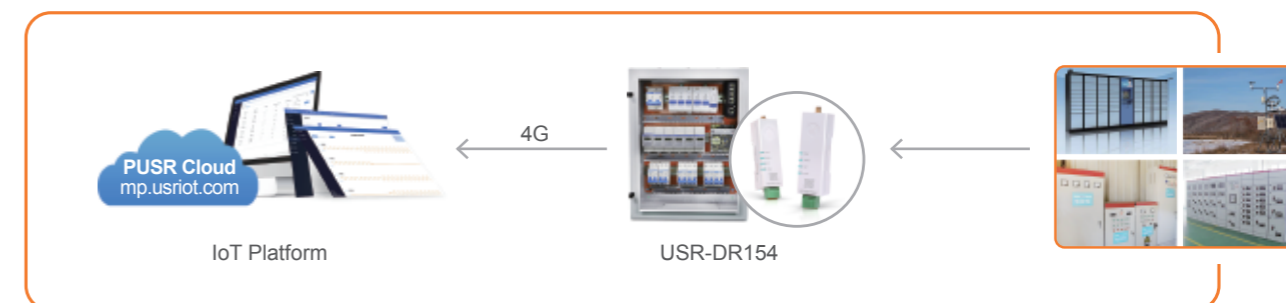

Key Parameters for 4G Modems

Model	USR-G786-G	USR-G771-E	USR-DR504-G	USR-DR502-E	USR-DR154-E
Appearance					
Frequency Band	LTE Cat 4: B1/2/3/4/5/7/8/12/13/18/19/20/25/26/28/38/39/40/41 WCDMA: B1/2/4/5/6/8/19 GSM: B2/3/5/8	LTE Cat 1: B1/3/7/8/20/28 GSM/GPRS/EDGE: 900/1800MHz	LTE Cat 4: B1/2/3/4/5/7/8/12/13/18/19/20/25/26/28/38/39/40/41 WCDMA: B1/2/4/5/6/8/19 GSM: B2/3/5/8	LTE Cat 1: B1/3/7/8/20/28 GSM/GPRS/EDGE: 900/1800MHz	LTE Cat 1: B1/3/5/7/8/20/28
SIM Slot	1*mini-SIM(2FF)	1*mini-SIM(2FF)	1*micro-SIM(3FF)	1*micro-SIM(3FF)	1*nano-SIM(4FF)
Region	Global	Europe	Global	Europe	Europe
Serial Port	1*RS485/232	1*RS485/232	1*RS485	1*RS485	1*RS485
Communication Protocol	TCP/UDP/DNS/HTTP/FTP/DNS	TCP/UDP/HTTP/MQTT/SSL/TLS/DNS	TCP/UDP/DNS/HTTP/FTP/DNS	TCP/UDP/HTTP/MQTT/SSL/TLS/DNS	TCP/UDP/HTTP/MQTT/SSL/TLS/DNS
TCP Server	✓	--	✓	--	✓
Modbus Gateway	✓	✓	✓	✓	✓
SMS	✓	✓	✓	✓	--
Power Supply	DC 9-36V	DC 9-36V	DC 9-36V	DC 9-36V	DC 5-24V
EMC Protection	IEC61000 level 3	IEC61000 level 3	IEC61000 level 3	IEC61000 level 3	IEC61000 level 2
Operating temperature	-35°C ~ +75°C	-35°C ~ +75°C	-35°C ~ +75°C	-35°C ~ +75°C	-25°C ~ +75°C
Housing	Metal housing, IP30 protection	Metal housing, IP30 protection	ABS housing, IP 30 protection	ABS housing, IP 30 protection	ABS housing, IP 30 protection
Installation	Desktop, wall mounting	Desktop, wall mounting	Din rail mounting	Din rail mounting	Din rail mounting
Dimensions (mm)	111.51*94*28 (L*W*H)	82.6*86*25 (L*W*H)	44.5*31.8*13.94 (L*W*H)	44.5*31.8*13.94 (L*W*H)	74*24*22mm (L*W*H)

Wastewater Treatment Monitoring System

The wastewater monitoring equipment can report data to the data monitoring center in real time using the 4G modem provided by PUSR. Through the cloud platform offered by PUSR, when monitoring data exceeds the threshold, management personnel can be notified via SMS and email for immediate maintenance.



Solar Energy Remote Monitoring

The USR-DR502 supports a variety of network protocols, including TCP/UDP/MQTT (SSL), and can send photovoltaic power generation data to the customer-specified data monitoring center, enabling real-time monitoring of photovoltaic power generation and other information.

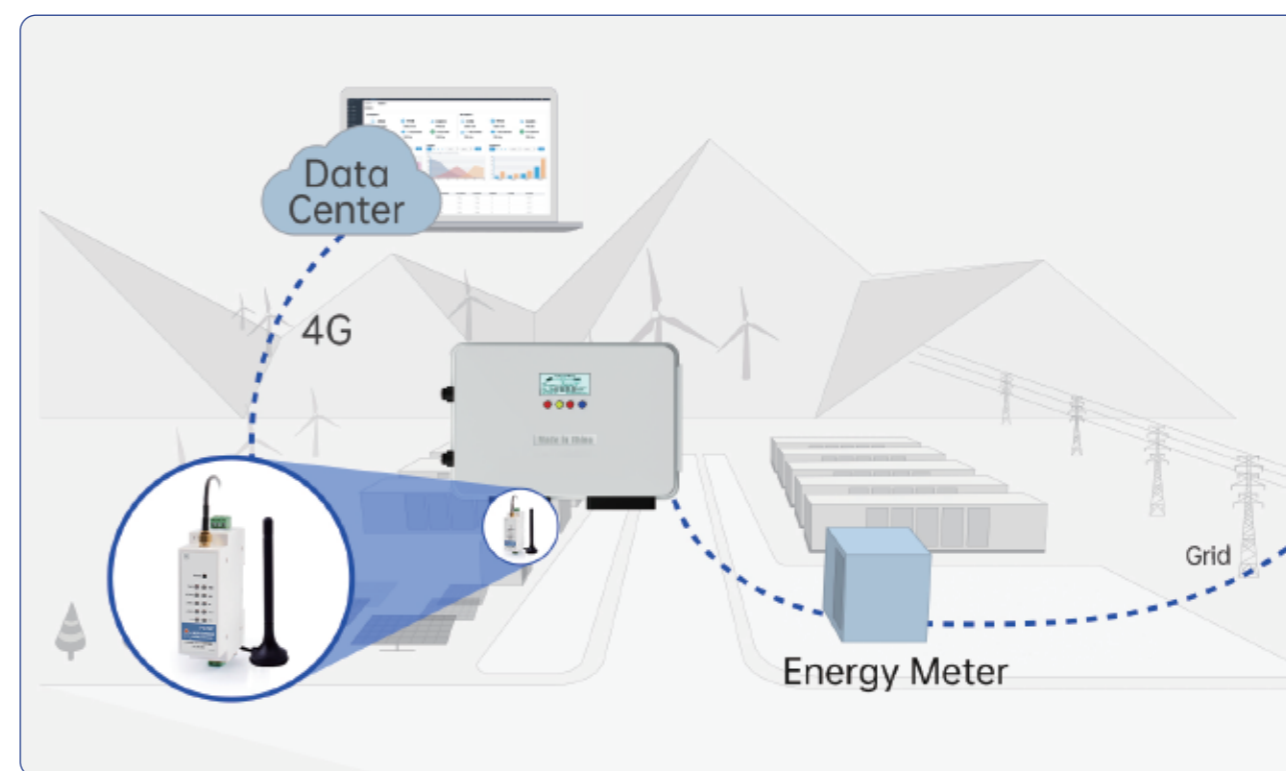

Serial Converter

Serial to Ethernet



Industrial Weighing Solutions

In the industrial weighing system, in addition to reading the obtained weight through the display instrument on site, the electronic scale also needs transmit the data to the server center through its own serial port.

So the solution is composed of Serial Converters, which is convenient for the remote management host to directly read the on-site electronic scale data through the TCP/HTTP/MQTT/UDP protocol, and manage the production status in real time.

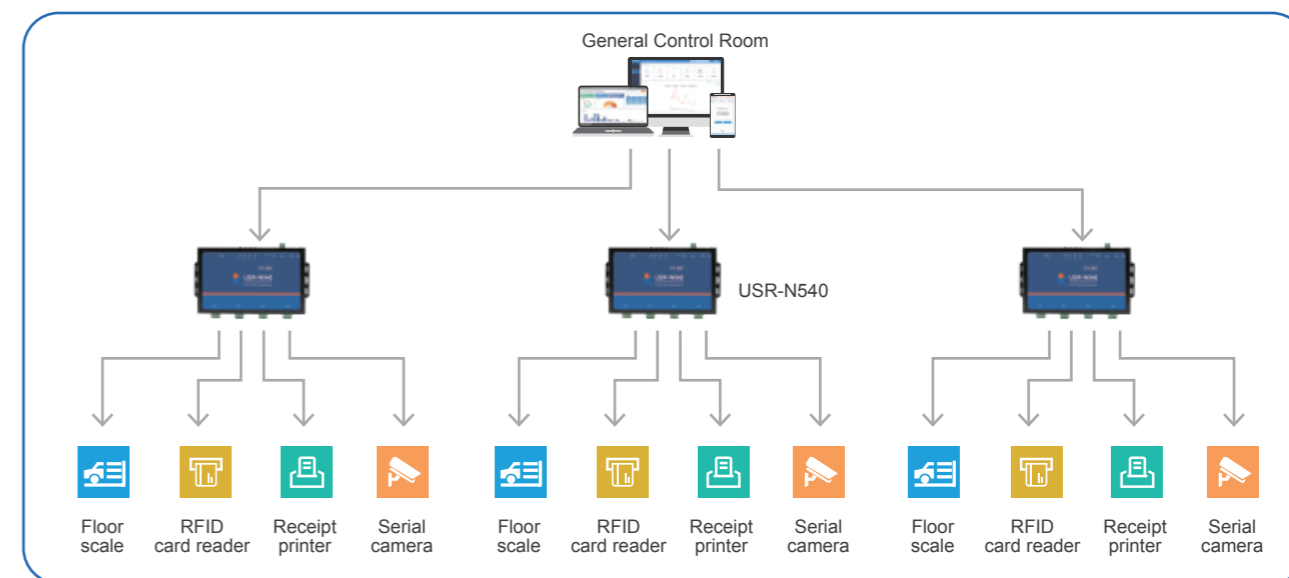

Smart Traffic

The serial device server can be used for remote monitoring and control of traffic equipment, control and information exchange of traffic lights, highway toll system and other equipment, providing high-quality travel services and improving the overall operating efficiency of transportation.

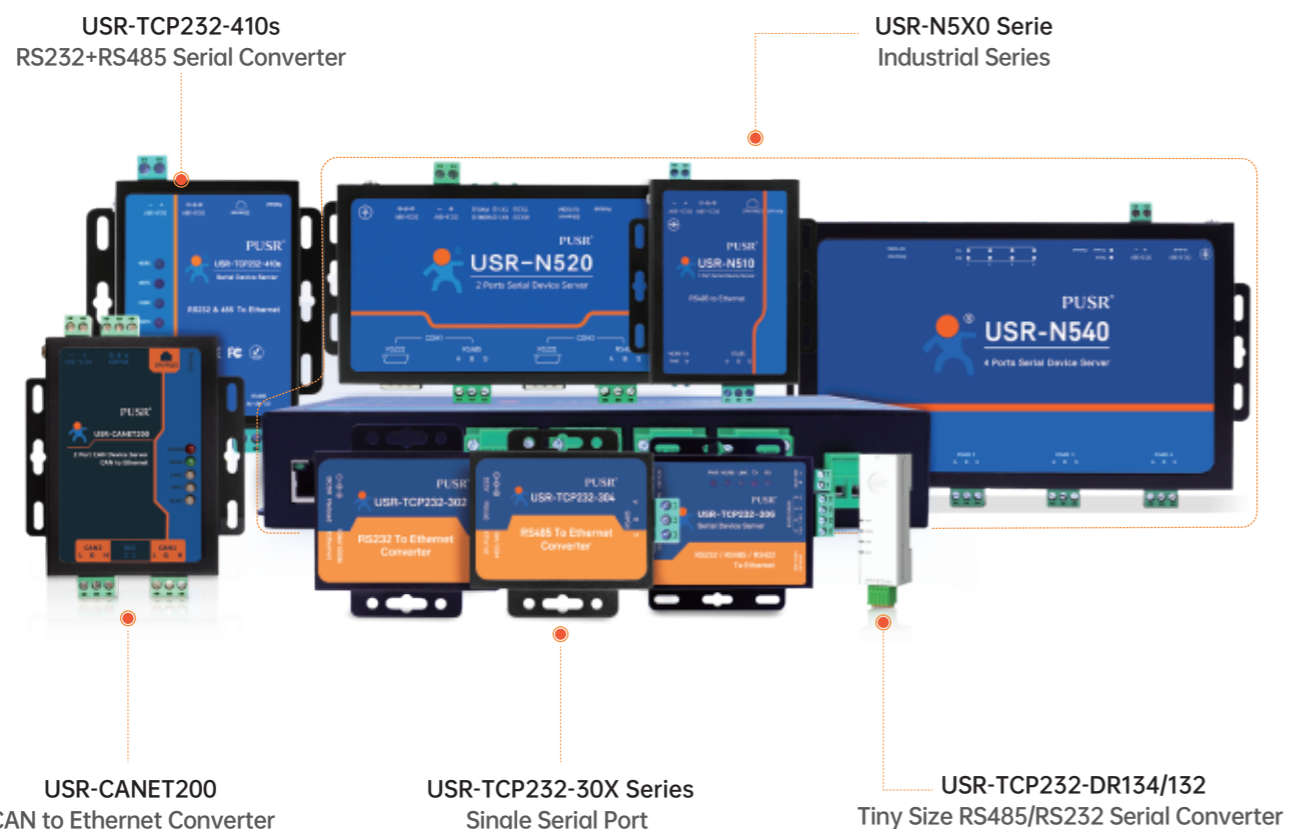
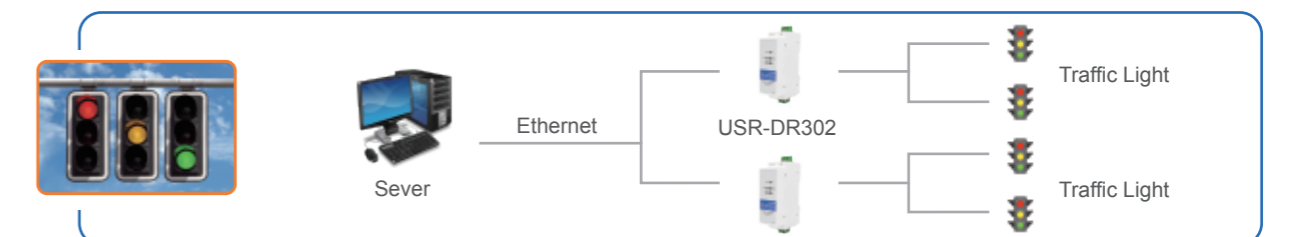





Edge Computing



Modbus Gateway



MQTT+SSL



Multiple Ports



Factory AGV Transportation Solution

As a new type of intelligent industrial equipment, the AGV car requires low-latency, accurate network data transmission, remote control in harsh environments, etc. W660 provides WiFi6 and Gigabit Ethernet port to ensure high-speed data transmission. USR-W660 also supports fast roaming function, which can ensure real-time, stability control and data reporting for the AGV car.

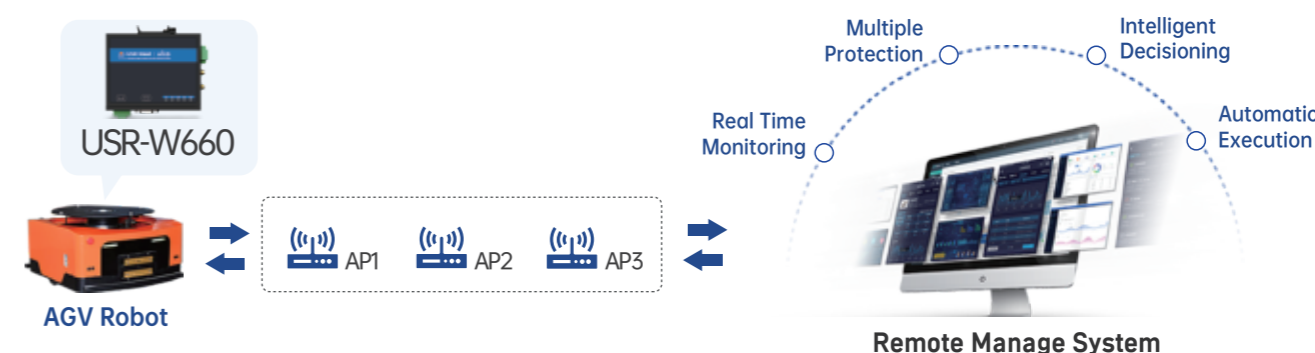

Smart Factory Data Collection and Transmission

Connect with the serial port/network port equipment in the factory, and upload the equipment operation data to the local monitoring platform or remote platform in real time; the staff can dynamically understand the operation status of the monitored equipment through the monitoring platform.

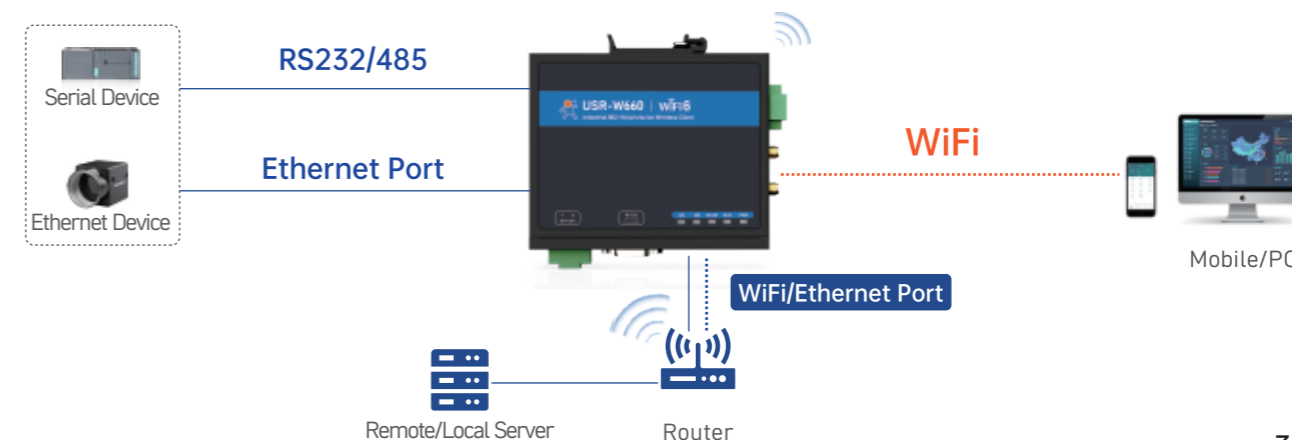

Serial Converter

Serial to WiFi |

USR-W630s
Dual Ethernet Port WiFi Serial Converter

USR-W660
Dual Band WiFi 6 Wireless Client

USR-W610
Single Ethernet Port WiFi Serial Converter

USR-DR404
RS485 to Wi-Fi/Ethernet



Dual Band WiFi 6



Wireless Roaming



RS485/232



Gigabit Ports

Serial Converter Series

Model	USR-N5X0	USR-TCP232-410s	USR-TCP232-30X	USR-DR30X	USR-DR13X
Appearance					
Processor	Cortex-M7	Cortex-M7	Cortex-M0	Cortex-M0	Cortex-M0
Serial Port	N510: 1*RS485 N520: 2*RS232/RS485 N540: 4*RS485 N580: 8*RS485	1*RS232+1*RS485	302: 1*RS232 304: 1*RS485 306: 1*RS485/232/422	DR302: 1*RS485 DR301: 1*RS232	DR134: 1*RS485 DR132: 1*RS232
Ethernet Port	1*10/100 Mbps RJ45 port	1*10/100 Mbps RJ45 port	1*10/100 Mbps RJ45 port	1*10/100 Mbps RJ45 port	1*10/100 Mbps RJ45 port
Communication Protocol	TCP/UDP/HTTP/MQTT/SSL/TLS/SNMP/Telnet	TCP/UDP/HTTP	TCP/UDP/HTTP	TCP/UDP/HTTP	TCP/UDP/HTTP
Modbus Gateway	✓	✓	✓	✓	✓
Modbus Poll	✓	✓	✓	✓	✓
Edge Computing	✓	--	--	--	--
Power Supply	DC 5-36V	DC 5-36V	302/304: DC 5-7V 306: DC 5-36V	DC 5-36V	DC 5-24V
EMC Protection	IEC61000 level 3	IEC61000 level 3	IEC61000 level 2	IEC61000 level 3	IEC61000 level 2
Operating temperature	-40 ~ +85°C	-40 ~ +85°C	-25 ~ +75°C	-40 ~ +85°C	-40 ~ +85°C
Housing	Metal housing, IP30 protection	Metal housing, IP30 protection	Metal housing, IP30 protection	ABS housing, IP 30 protection	ABS housing, IP 30 protection
Installation	Desktop, wall mounting	Desktop, wall mounting	Desktop, wall mounting	DIN rail mounting	DIN rail mounting, wall mounting
Dimensions (mm)	N510: 115.7*94.0*25.5 N520: 150.0*98.87*30.0 N540: 222*142*29 N580: 222*122*35 (L*W*H)	82.5*86*25 (L*W*H)	302: 66.3*70.0*25.0 304: 73.2*70.0*25.0 306: 98.0*86.0*25.0 (L*W*H)	109.66*28*64.71 (L*W*H)	74*24*22mm (L*W*H)

Wifi Converter Series

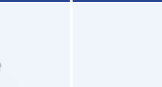
Model	USR-W660	USR-W630s	USR-W610	USR-DR404
Appearance				
Processor	IPQ6000	QCA9531	MTK7688	MTK7688
Ethernet Port	2*10/100/1000 Mbps RJ45 port, 1WAN/LAN+1LAN	2*10/100 Mbps RJ45 port, 1WAN/LAN+1LAN	1*10/100 Mbps RJ45 port, 1WAN/LAN	1*10/100 Mbps RJ45 port, 1WAN/LAN
WiFi Standard	Dual band WiFi 6, 802.11 a/b/g/n/ac/ax	Dual band WiFi 5, 802.11 a/b/g/n/ac	2.4G, 802.11b/g/n	2.4G, 802.11b/g/n
WiFi Mode	AP/STA/AP+STA	AP/STA/AP+STA	AP/STA/AP+STA	AP/STA/AP+STA
WiFi Roaming	✓	--	--	--
Serial Port	1*RS485/232	1*RS485/232	1*RS485/232	1*RS485
Power Supply	DC 9-36V	DC 9-36V	DC 5-36V	DC 5-36V
Communication Protocol	TCP/UDP/HTTP/MQTT/SSL/TLS/SNMP	TCP/UDP/HTTP/MQTT/SSL/TLS/SNMP	TCP/UDP/HTTP/MQTT/SSL/TLS	TCP/UDP/HTTP/MQTT/SSL/TLS
Modbus Gateway	✓	✓	✓	✓
Modbus Poll	✓	✓	✓	✓
EMC Protection	IEC61000 level 3	IEC61000 level 3	IEC61000 level 3	IEC61000 level 3
Operating temperature	-25°C ~ +70°C	-25°C ~ +75°C	-40°C ~ +85°C	-25°C ~ +70°C
Housing	Metal housing, IP30 protection	Metal housing, IP30 protection	Metal housing, IP30 protection	ABS housing, IP 30 protection
Installation	Wall mounting, DIN rail mounting	Wall mounting	Wall mounting	DIN rail mounting
Dimensions (mm)	115*94*29 (L*W*H)	110.5*105*26 (L*W*H)	84*84*25 (L*W*H)	109.66*28*64.71 (L*W*H)



- Standard LoRaWAN
- RS485/232
- LoRaWAN Class C
- Industrial Grade



Smart Park

Temperature, humidity, light, PM2.5 and other sensors collect air, traffic flow and other data in the park, and report the collected data to the data monitoring center through the LoRaWAN DTU and LoRaWAN gateway provided by PUSR, so as to conduct real-time monitoring of the dynamic situation of the park to make a rapid response to abnormal situations.

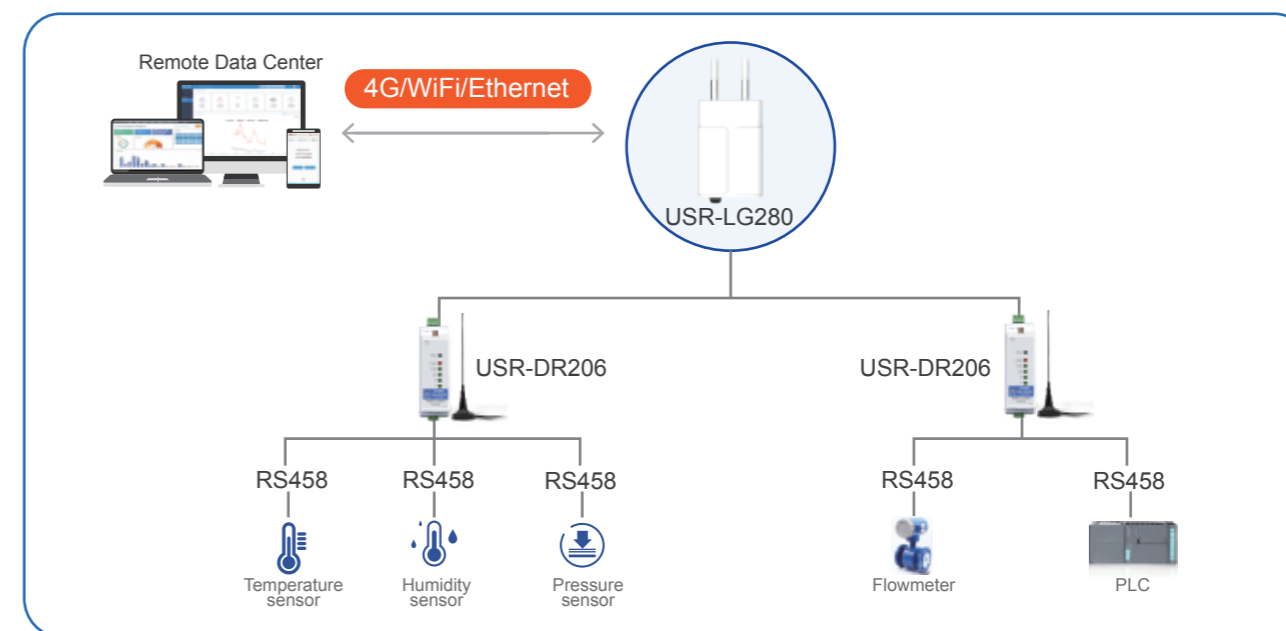

Smart Agriculture

In some remote areas, 4G network is unstable, and remote control of agricultural irrigation and data collection through loRa network can solve the problem well. Point-to-point LoRa radio provided by PUSR can realize point-to-point and point-to-multipoint data transmission, remote agricultural irrigation, soil data collection and so on.

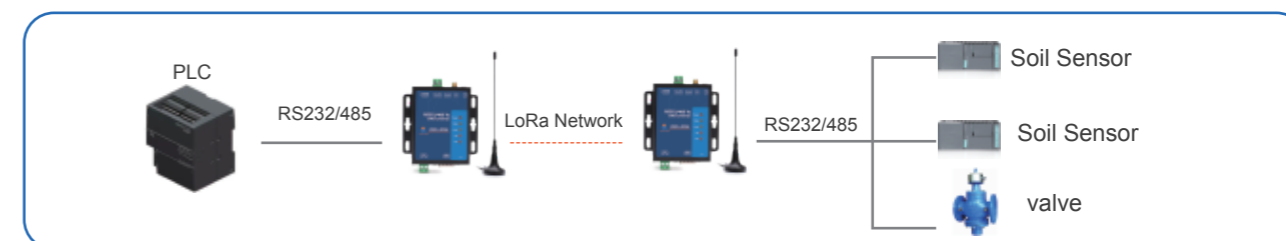

Swarm Mesh Wireless Client

USR-FQ610 is a self-organizing ad-hoc network of autonomous mobile devices that can communicate among 1024 devices without a central controller.



USR-FQ610

- Rapid Networking
- High-speed Data Transmission
- Automatic Relay



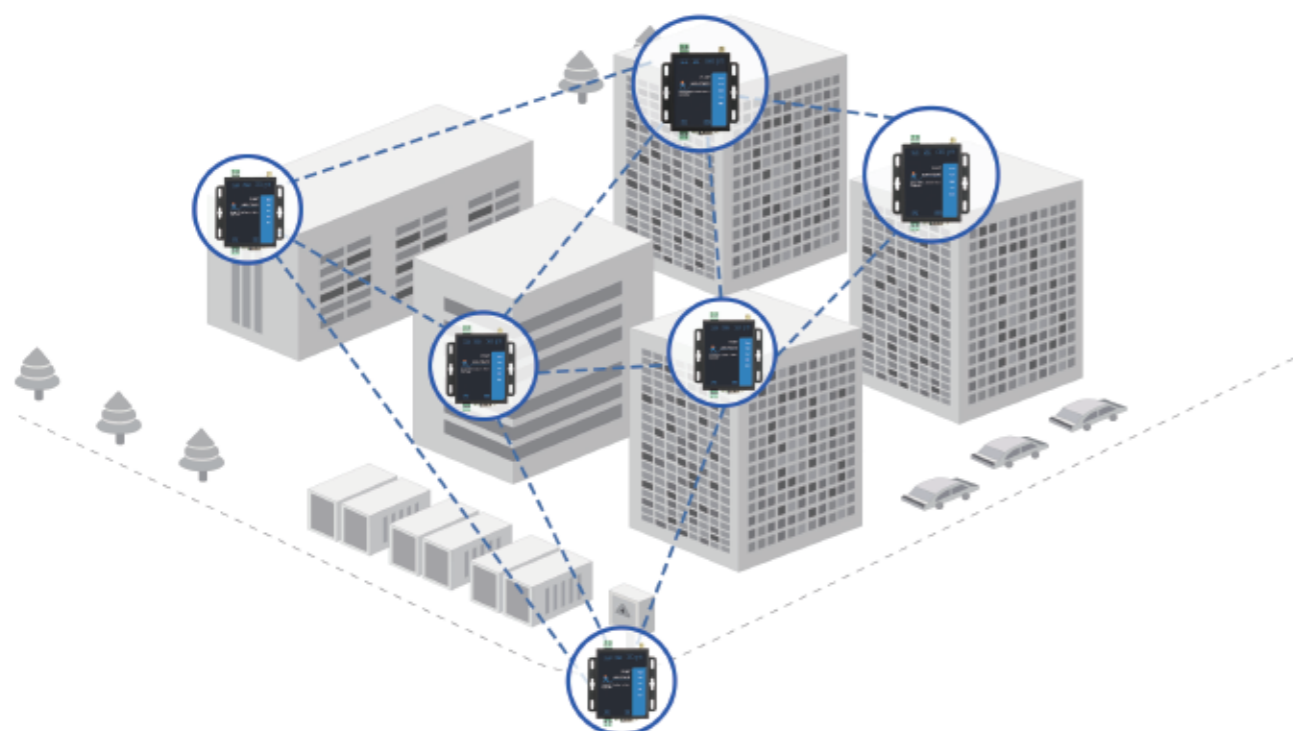

Application

Complex Environmental Communication

Factors such as limited resources and complex building structures restrict large buildings, multi-story basements, tunnels, and mines. Ground signals cannot be directly transmitted underground. The swarm mesh (ad hoc) network technology automatically relays wireless networking through portable terminals and introduces signals downward through multi-hop forwarding to quickly achieve ground and underground interoperability.



Key Parameters of Lora/Swarm

Model	USR-LG280	USR-DR206	USR-LG206	USR-FQ610
Appearance				
LoRa Protocol	Standard LoRaWAN	Standard LoRaWAN	Private LoRa Protocol, Point to Point	Private Swarm
LoRa Band	AU915	AU915	803-930MHz	902-928MHz
Cellular Band	LTE Cat 4: B1/2/3/4/5/7/8/28/40 WCDMA: B1/2/4/5/8 GSM/EDGE: B2/3/5/8	--	--	--
Region	Australia, New Zealand, Latin America	--	--	--
SIM Slot	1*mini-SIM(2FF)	--	--	--
Ethernet Port	1*10/100/1000 RJ45 port(PoE passive in)	--	--	1*10/100 Mbps RJ45 port
WiFi Standard	2.4G, 802.11b/g/n	--	--	--
WiFi Mode	AP/STA	--	--	--
Serial Port	--	1*RS485	1*RS485/232	1*RS485/232
Power Supply	1. DC 12V with M12 Connector 2. 802.3 of PoE input	DC 8-24V with terminal block connector	DC 9-36V, terminal block connector or DC socket are optional	DC 9-24V, terminal block connector or DC socket are optional
Communication Protocol	TCP/HTTP/MQTT	--	--	TCP/UDP
Capacity	2000 end nodes	--	--	--
EMC Protection	Level3	Level 3	Level 3	Level 2
Operating temperature	-40 ~ +70°C	-40°C ~ +85°C	-30°C ~ +80°C	-25°C ~ +75°C
Housing	ABS housing, IP 67 protection	ABS housing, IP 30 protection	Mental housing, IP 30 protection	Mental housing, IP 30 protection
Installation	Wall mounting, pole mounting	DIN-rail mounting	Wall mounting	Wall mounting
Dimensions(mm)	240*164*90.9(L*W*H)	109.66*64.67*28(L*W*H)	82.5*86*25(L*W*H)	86*82.5*25(L*W*H)

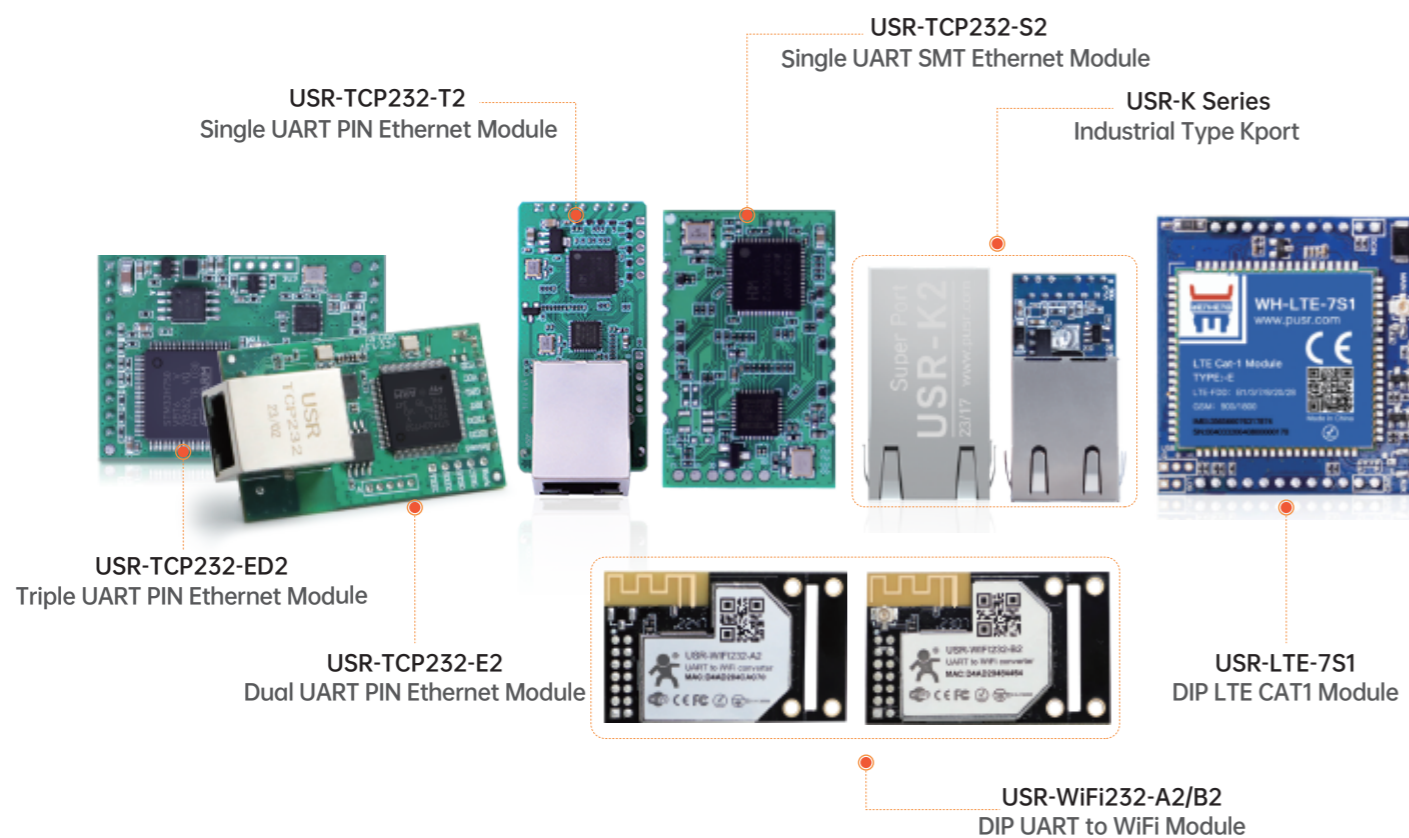
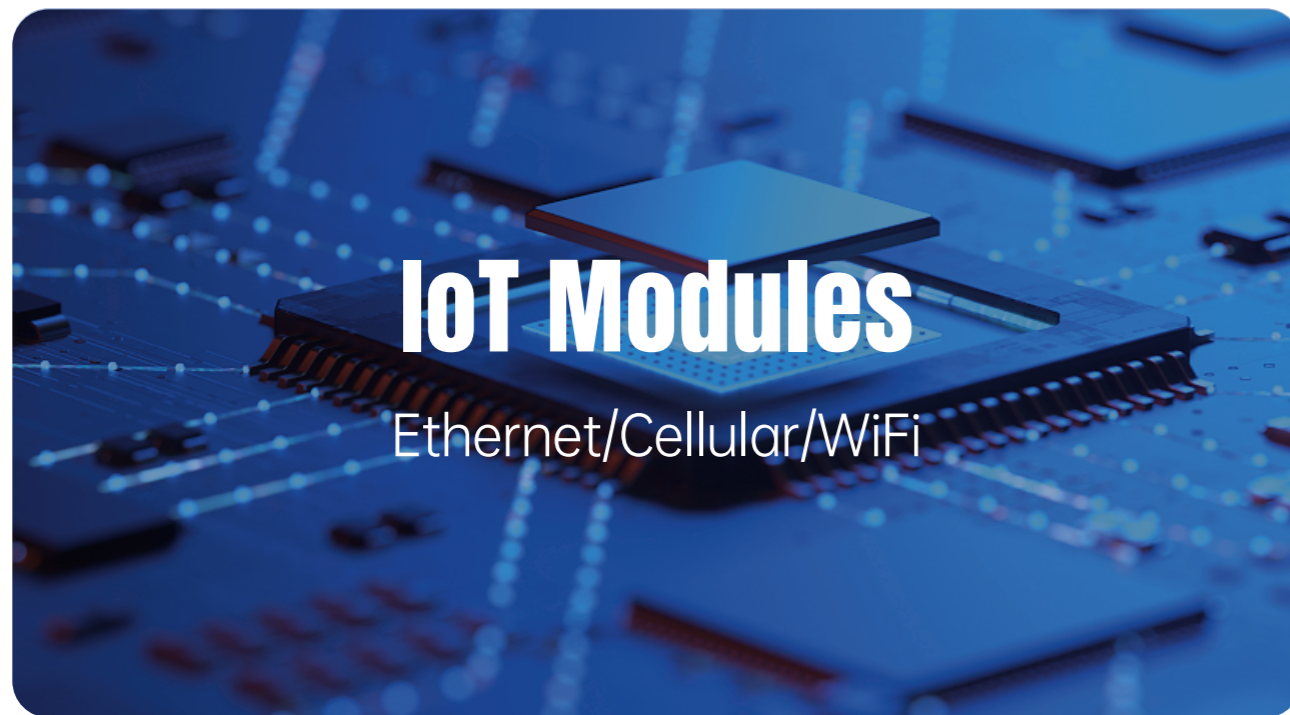

RFID Reader Solutions

PUSR IOT provides Ethernet modules and embeds them into RFID solutions, which can help schools and parents know the time of arrival and departure of each student. The intelligent RFID system has not only strengthened internal security management, but also provided guarantee for education work.

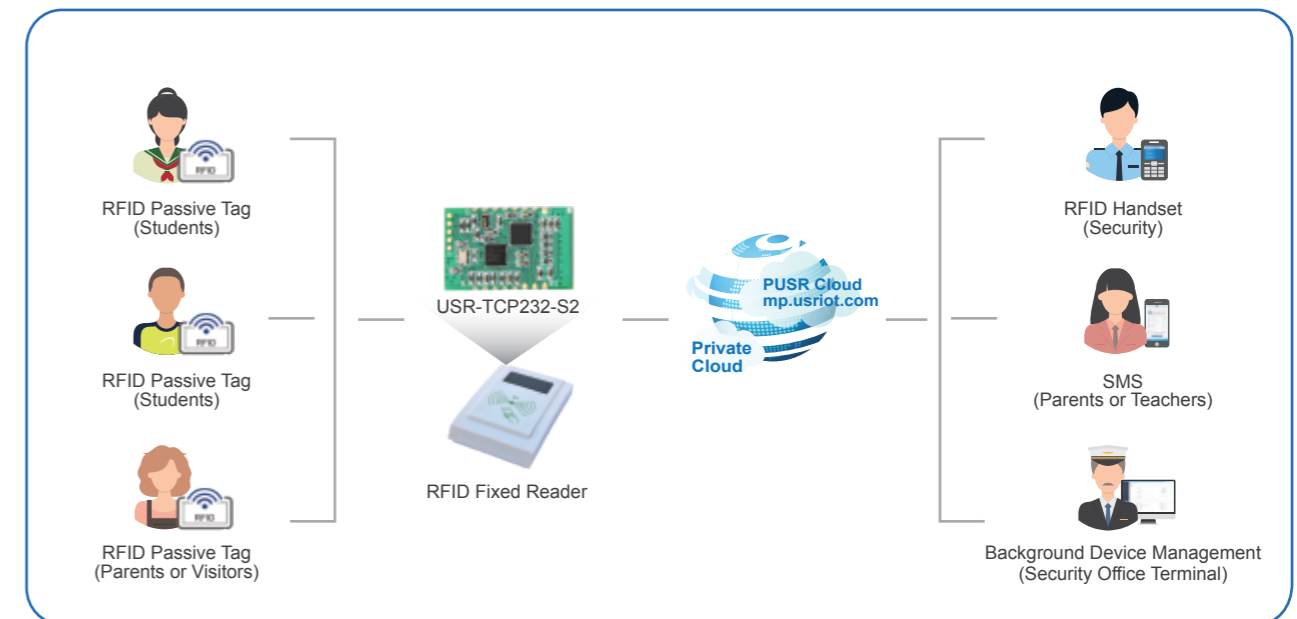

Ethernet /4G Module Key Parameters

Model	USR-TCP232-E2/ED2	USR-TCP232-T2/S2	USR-K Series	USR-LTE-7S1
Appearance				
Connectivity	Ethernet	Ethernet	Ethernet	Cellular
UART	TCP232-E2: 2*TTL TCP232-ED2: 3*TTL	1*TTL	1*TTL	1*TTL
Communication Protocol	TCP/UDP/HTTP/MQTT	TCP/UDP/HTTP	TCP/UDP/HTTP	TCP/UDP/HTTP/MQTT
SSL Encryption	✓	--	--	✓
Modbus Gateway	✓	✓	K5: -- K2/K3/K6/K7: ✓	--
Package	DIP	T2: DIP S2: SMT	DIP	DIP



Product Video



PIN/SMT Package



Small Volume



Industrial Grade



WiFi/Ethernet/
4G Optional

IoT Platform

mp.usriot.com

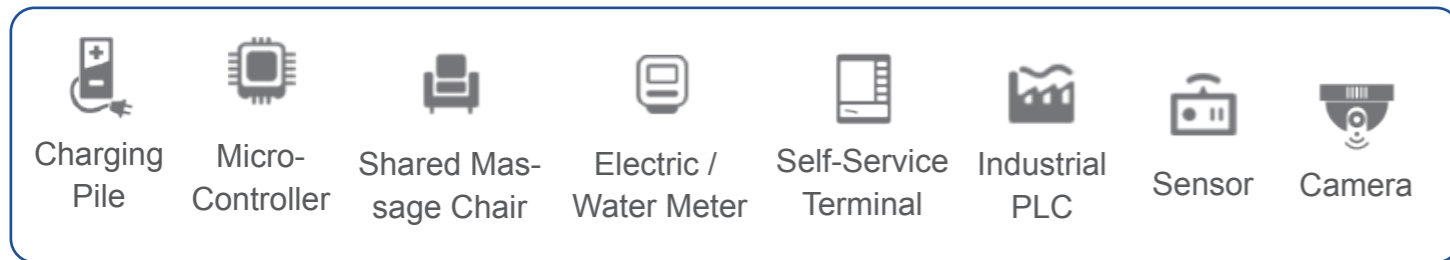

Network Management

Online remote networking function enables easy network construction and network management through SD-VPN technology. This technology solves the pain points of expensive broadband fees, complex VPN settings, and high technical thresholds required for traditional remote access.

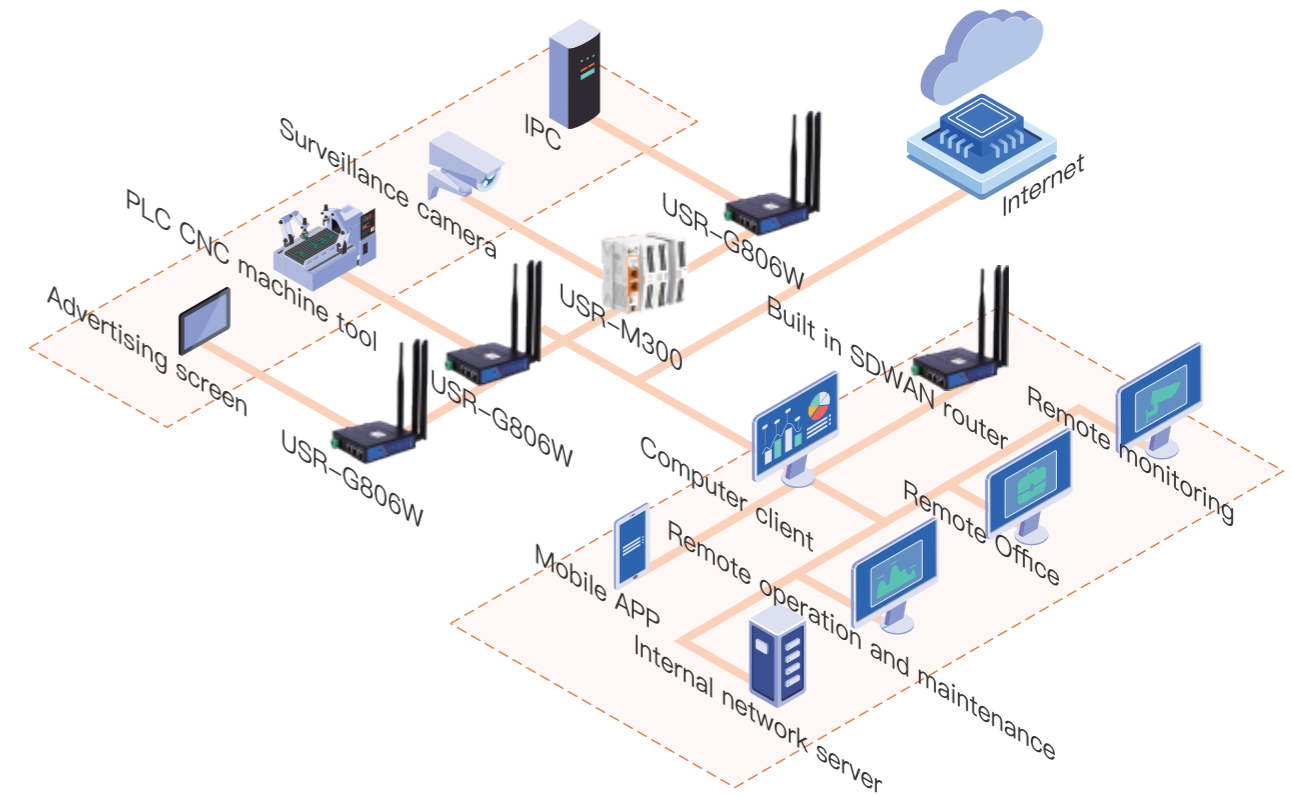

SIM Card

Basic SIM Information

Data Service Checking

Multiple Data Service Plan



sim.usr.cn



Large R&D and Production Capacity, Customized Development of IoT Terminals, and Mass Delivery.

ODM Electronic Design and EMS Electronic Manufacturing Services.

Industry Customized Products :



Water Telemetry Terminal

Serial /IO acquisition, 4G water transmission platform, 427, 651 protocol



Freezer Collection Terminal

485/TTL temperature and humidity, power consumption, WiFi transmission MQTT platform



Instrument Networking Board

485/4~20mA mining pressure, liquid level meter, 4G upload

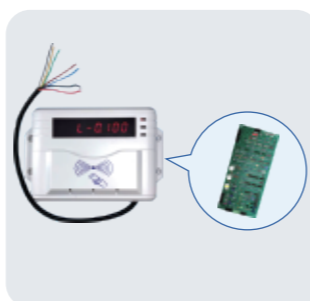

The Campus Water Machine Control Panel

4G Cat.1 on the cloud, docking Alipay payment, TTL signal control water



Hotel Service Robot Main Control Board

Top allied WiFi / 4g, bottom allied front-end ports, CAN/ serial sensors



Car Locator

GNSS location, location over cellular networks on the cloud

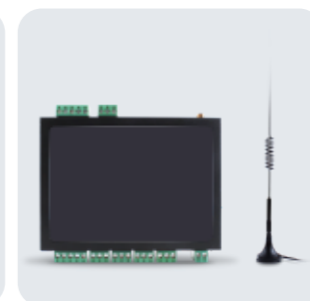

Breeding Power off Alarm

IO detection power off, power off instant large capacitor to achieve 4G upload



The Cooling/Heating Temperature Control Board

Linkage control valve, temperature control panel lora, 4g transmission

Industry Product

New



4G/5G Camera: Intelligent multi-link alert ball machine

Key Features	Description
Extendable IPC	Can be connected to an ordinary camera(Only Onvif protocol).
Intelligent Detection	Motion detection & motion tracking.
Alarm	It will send alarm when detecting human movement.
Electronic Fence	Supports user-defined area division of alarm detection areas.
Night Vision	Supports full color and infrared night vision.

New



DIN-Rail Power Supply: 12V/24V output | 85~264V AC input voltage| -40~70°C

Model	USR-D12-15	USR-D24-15	USR-D12-24	USR-D24-36	USR-D12-54	USR-D24-60
Output Power	15	15	24	36	54	60
Nominal Output Voltage/ Current (Vo/Io)	12V/1.25A	24V/0.63A	12V/2A	24V/1.5A	12V/4.5A	24V/2.5A
Dimensions	90x58x17.5mm		90x35x58mm		90x52x58mm	



Dongle Pocket WiFi

Plug-and-Play, High Speed, Mini Size



RS485 Energy Meter

Modbus RTU, DL/T645



Vibrating Sensor

Triaxial Vibration Monitoring, Temperature Data Collection



Temperature and Humidity Sensor

RS485 Interface, Modbus RTU



Serial Relay Controller

RS232+RS485, DI, DO, AI



MORE>

Sensors/Controller/Solar Panel...

QUALITY ASSURANCE

Low Temperature Test



High Temperature Test



EMC Test



Payload Test



Aging Tests

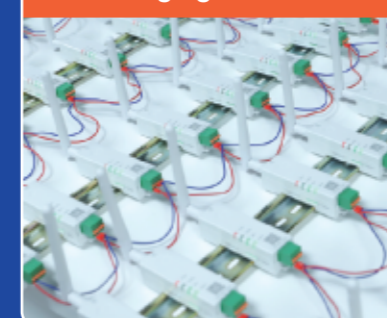

Field Test



Welcome

Jinan Headquarters: Ceibs Alumni Industrial Building, No.3 Maoling Mountain Road, Lixia District, Jinan City

Jinan Production Base: Ji 'nan Century Avenue 2566 Dia double Innovation Industrial Park

Suzhou Production Base: Fumin Industrial Park, No.818 Songjia Road, Wuzhong District, Suzhou

